

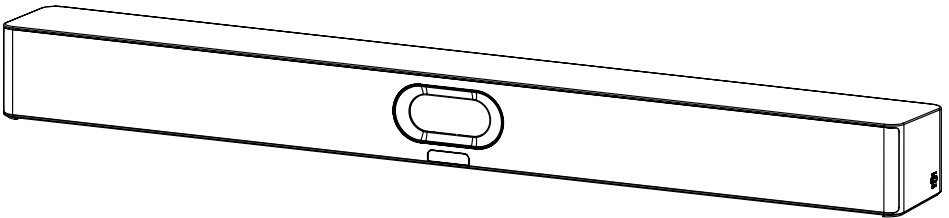

Scan to watch
the installation video.



MeetingBar A40



Quick Start Guide V1.5

English | Deutsch | Français | Español

CONTENT

English.....	1
Deutsch.....	13
Français.....	25
Español.....	37

1 Package Contents



MeetingBar A40

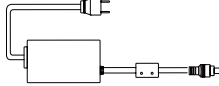

Power Adapter
(48 V/1.36 A)
(3.5 m, 11.48 ft)

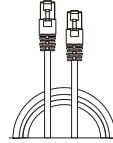

CAT5e UTP
(RJ45 - RJ45) Cable
(3 m, 9.84 ft)

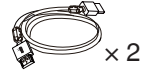

HDMI 2.0 Cable
(1.8 m, 5.91 ft)

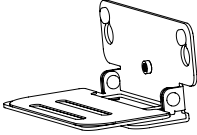

Mounting Bracket



Screw
6 x 30 mm, white,
Polyamide

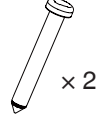

Screw
T4 x 30 mm, FA-
HOZN3+



Screw
1/4 inch x 12 mm



Screw
1/4 inch x 13 mm

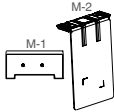

TV-Clip Mount



Screw
1/4 inch x 8 mm



Velcro
(One is on the M-2)



Silicone Pad
(38 x T1.2 mm)



Cable Cover



Screw
M2 x 4 mm, CM-
HOZN3+



Cable Tie
(20 x 200 mm)



Quick Start Guide

Optional Packages

A



VCR11 and
AAA Battery x 2

B

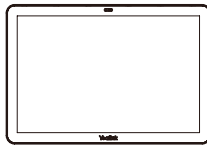

CTP25 Package

C

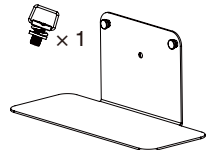

Table-top Stand

D

We recommend that you use these three accessories together.



MeetingDisplay
65/75/86

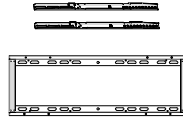

MD-Wallmount

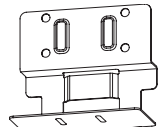

MD-AVBracket-S

We recommend that you use the accessories provided or approved by Yealink. The use of unapproved third-party accessories may result in reduced performance.

2 Hardware Interface Instructions

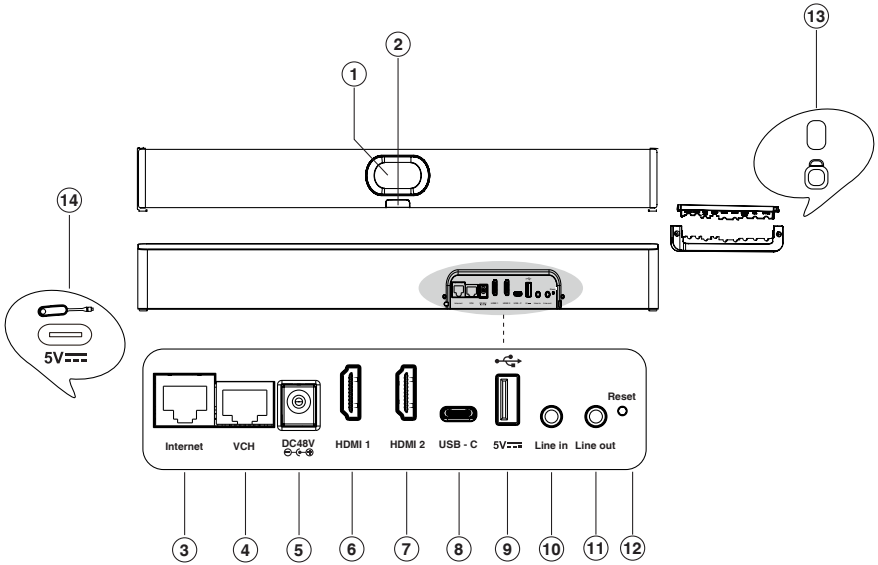

No.	Item	Description
1	Camera	Camera with an electric privacy shutter.
2	LED Indicator	Indicate the device status.
3	Internet	<ul style="list-style-type: none"> Connect to a Yealink MeetingDisplay's LAN port to access the network, provided that the MeetingDisplay is connected to the Internet. Connect directly to the network for Internet access.
4	VCH	<ul style="list-style-type: none"> Connect to a Yealink CTP Touch Panel. Connect to a microphone. Connect to a PoE switch.
5	DC48V	Connect to a power adapter.
6, 7	HDMI 1 & HDMI 2	<ul style="list-style-type: none"> Connect to a display for video image output. You need to use HDMI 1 Port first when using only one display.
8	USB-C 3.0 (back)	Connect to a PC for content sharing or BYOD.

9	USB-A 2.0	<ul style="list-style-type: none"> • Connect to a Yealink MeetingDisplay to synchronize configurations and integrate features. • Connect a USB accessory, such as a mouse.
10, 11	Line-in/Line-out	Connect to an audio output/input device via a 3.5 mm audio cable.
12	Reset Key	Reset to factory defaults.
13	Security Slot	Connect a universal security cable to the device so that you can lock it down.
14	USB-C 3.0 (side)	Connect to a Yealink Wireless Presentation Pod for pairing.

3 Basic Connection



- Display requirement: A resolution of 1080p or higher, and a port that supports HDMI 1.4 or higher.
- If you only need to use one display, please connect to HDMI 1 port.

MeetingBar A40

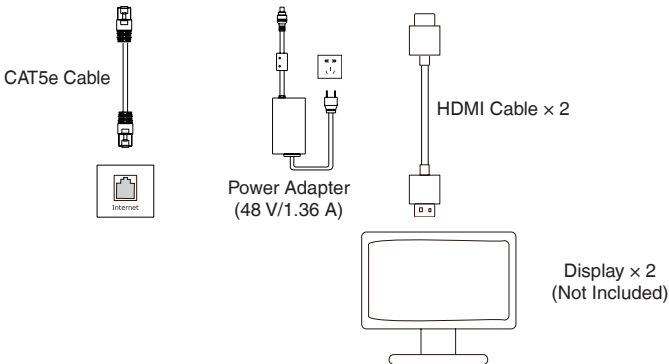
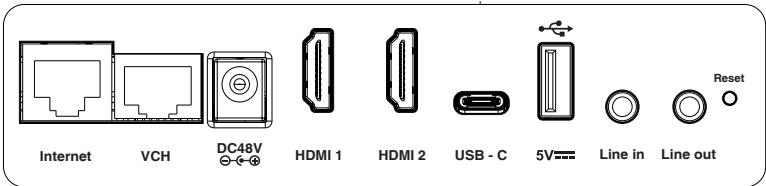

4 Connect MeetingDisplay with A40 (Optional)

- USB 2.0 (A-B) cable is included in MD-AVBracket-S's package.
- If the CAT5e cable from MeetingBar A40 is not connected to the LAN port of MeetingDisplay, then it should be connected to an external network port.

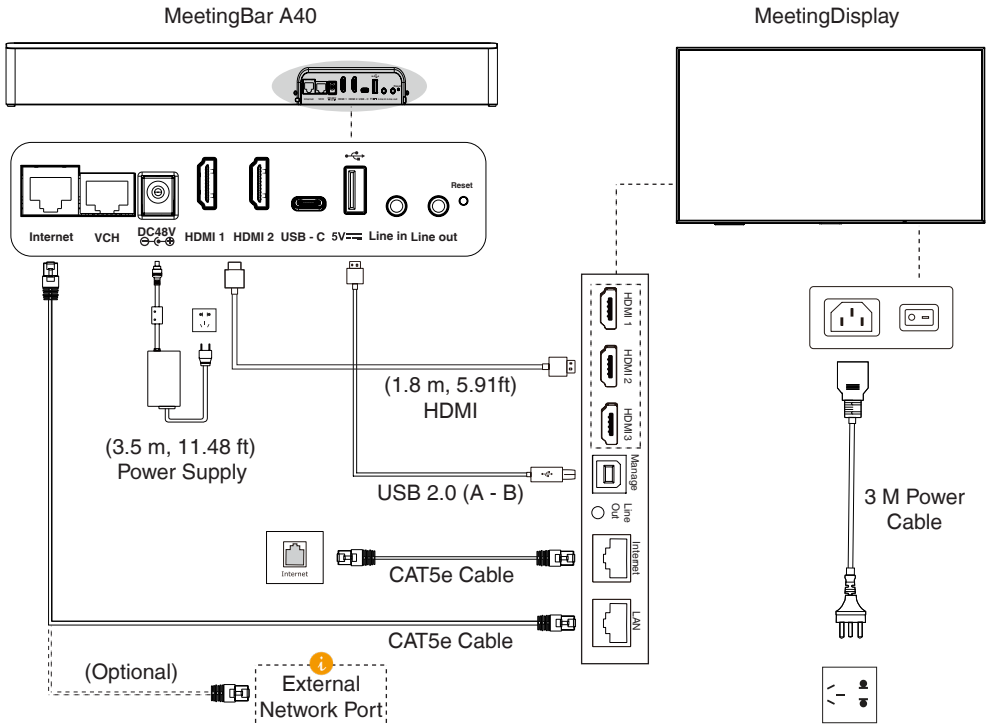

5 Connect CTP25 with A40 (Optional)

Option 1: Direct Connection with an Ethernet Cable

Use a network cable to connect the CTP25 to the A40.

MeetingBar A40

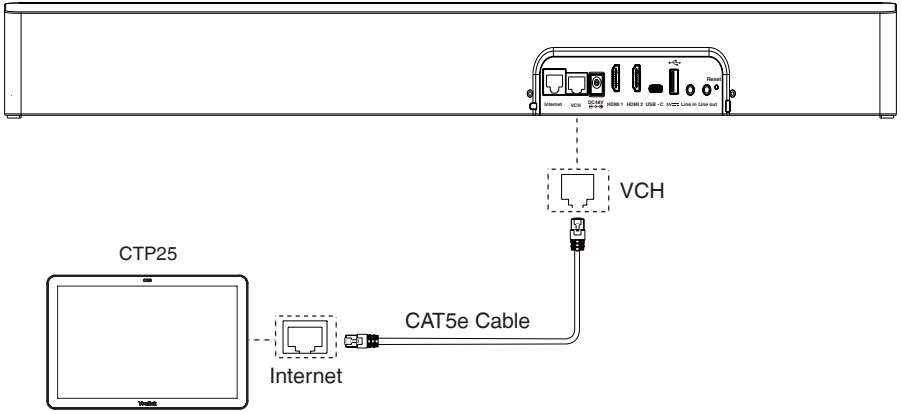

Option 2: Connection on the Same LAN



A40 and CTP25 need to be on the same LAN.

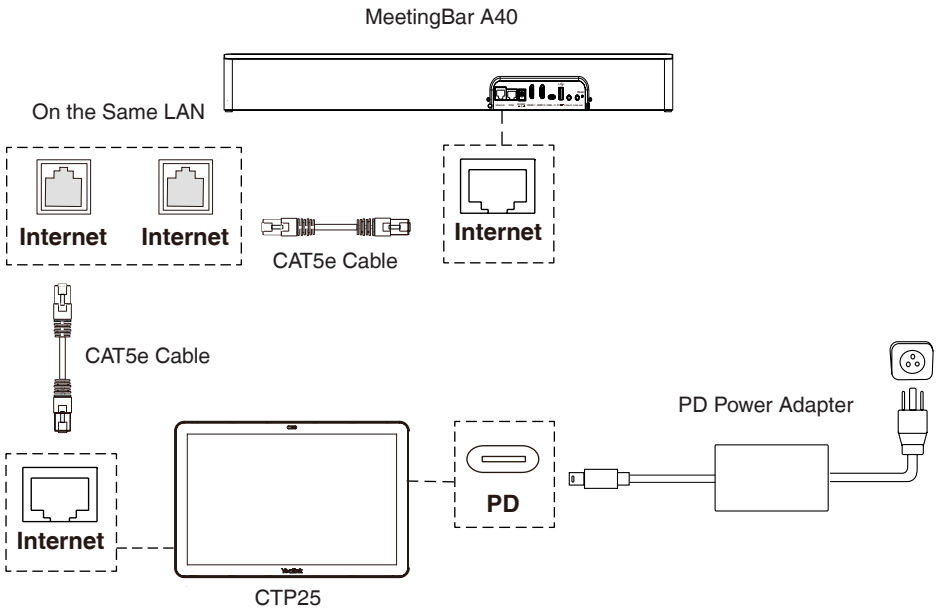

6 Assemble Cable Cover

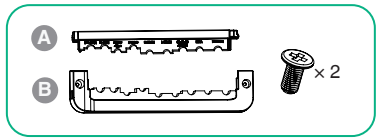

1 Find the two slots on the back of A40.

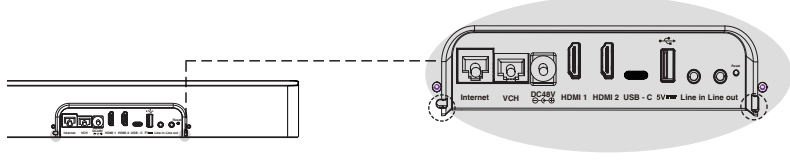

2 Fit part A of the cable cover into the slots.

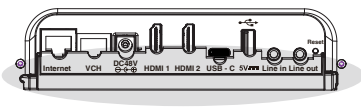

3 Assemble part B and fix the screws.

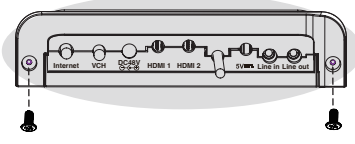

7 Installation

Option 1: Mount on Yealink MeetingDisplay



Installation Video

1

- You need to purchase MeetingDisplay and MD-AVBracket-S separately. For installation, please refer to the **MD-AVBracket-S Quick Start Guide** included in the corresponding package.
- Another 6 screws (1/4 inch x 12 mm) are included in the MD-AVBracket-S's package.

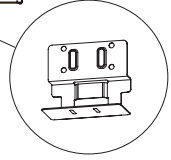
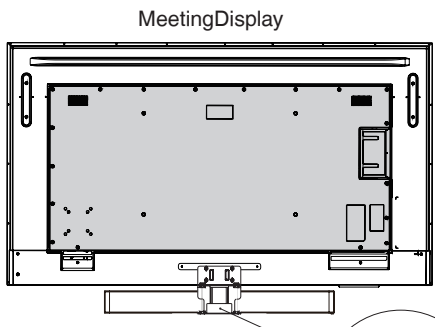
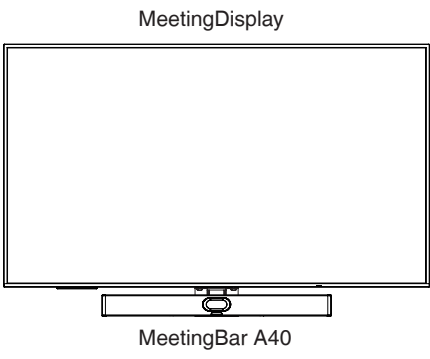

Option 2: Mount on a wall

Step 1: Determine A40 position.

The mounting height affects your camera view. The recommended installation height is 110 cm above the ground, and the reserved distance between A40 and TV should be greater than 1 cm.

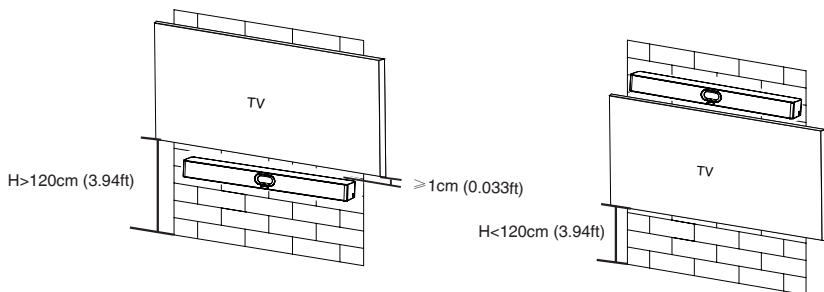

Step 2: Mount the A40 to the wall.

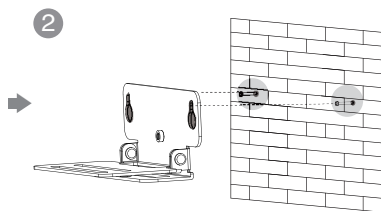
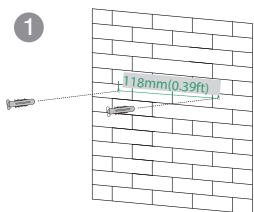
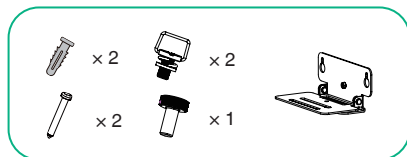

Hole depth: 30 mm (0.098ft) Hole diameter: 6 mm (0.02ft)

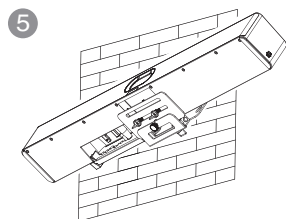
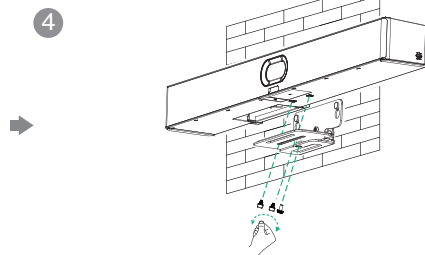
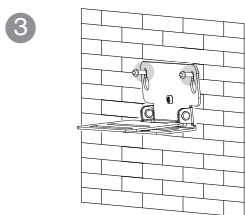

Option 3: Mount above a TV or a display



- The M-2 bracket can be inserted into the M-1 in two directions. Here, we will focus on one direction for illustration.
- Due to device weight, it is advisable to avoid mounting the device on slim TVs to prevent potential falls or damage to the screen.

1

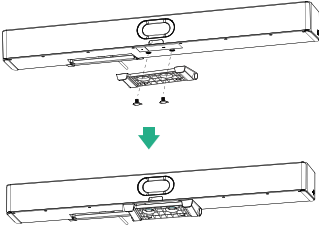

2

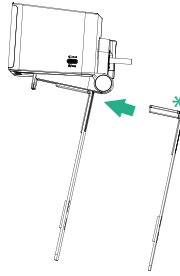

Pay attention to the direction of M-2

3

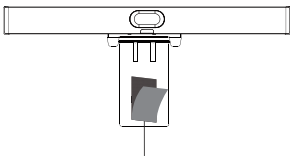

Velcro A is posted on the inside of M-2 by default

4

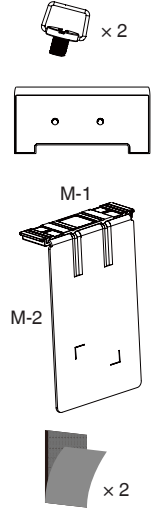
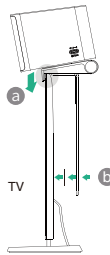

Option 4: Put on a flat surface

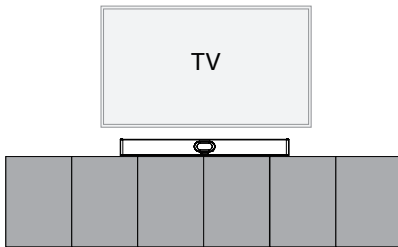
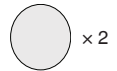

On the desk

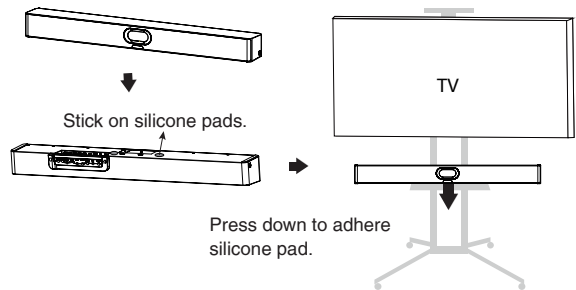

On the TV stand cart platform
(purchase separately)

Option 5: Embed in the wall



- The mounting height affects your camera view. The recommended installation height is 110 cm above the ground.
- Keep the front of the A40 flush with the wall surface.
- The recommended on the left, right, and top sides of the A40 is less than 0.5 cm.
- Leave a 5 ± 0.5 cm distance between the back of the A40 and the wall surface for cable connections.

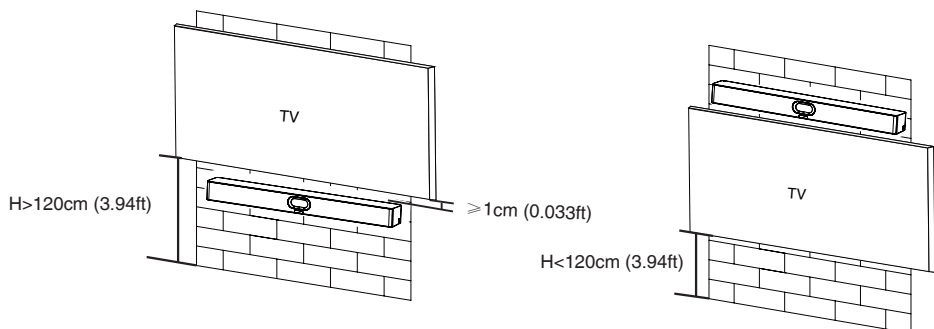

Option 6: Mount on the table-top stand



Refer to the **8 Adjust the Camera Tilt** section for bracket adjustment.

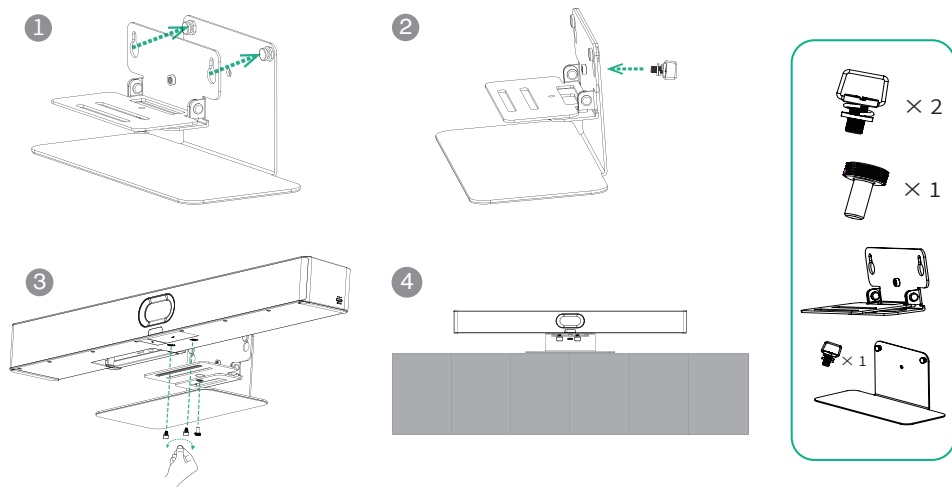

8 Adjust the Camera Tilt

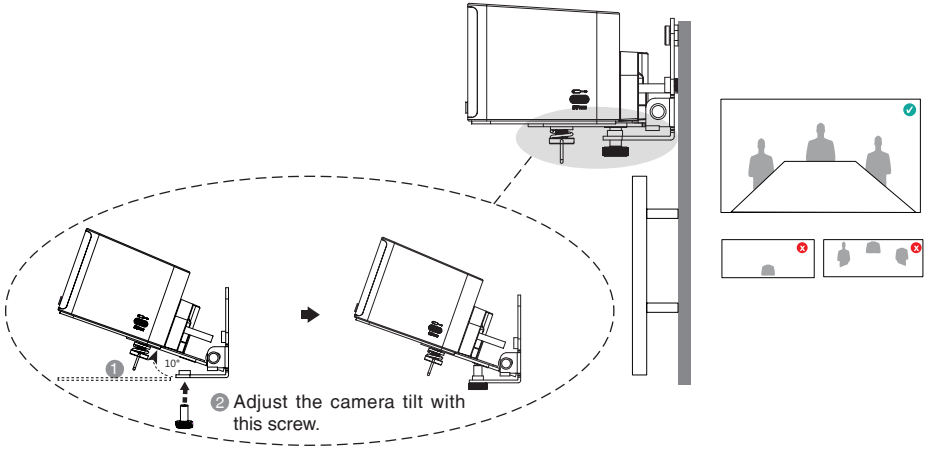

9 VCR11 (Optional)



You can use the remote control (not applicable to Zoom version) or CTP25 to operate the A40. If a touch display device is connected, you can also operate the A40 directly on the touch screen.

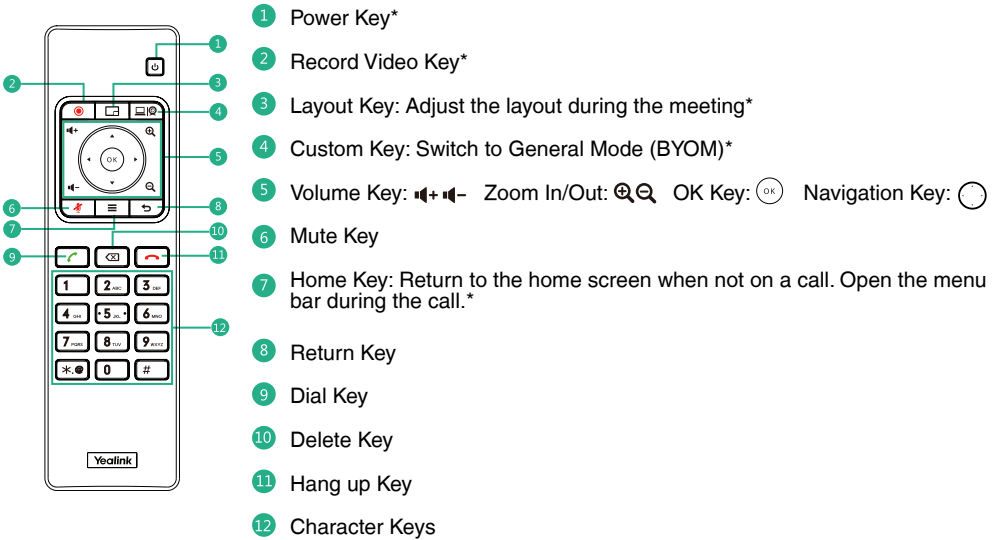

* Coming Soon

The supported keys in different modes may be various.

10 Pair with the CTP25 (Optional)

For a better pairing experience, we recommend starting the A40 first and then the CTP25.

Pair Manually

If you purchased a bundle kit or connected CTP25 to A40 via a network cable, A40 and CTP25 would be paired automatically. You can go to **Initialization** directly.

On the CTP25, enter the IP address and pairing code of the A40 on display.

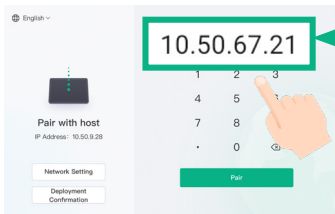

CTP25

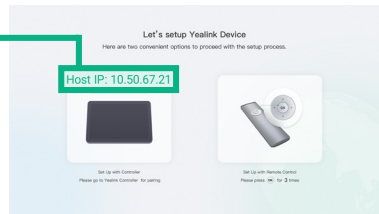

MeetingBar A40

Initialization

1. If the CTP25 is restored to factory settings, you need to change the default password (0000) of the CTP25.
2. Initialize **Language**, **Network**, **Time Zone** and **Auto Update**, and select the desired platform. If you select **General Mode (BYOM)**, refer to the **11 General Mode (BYOM)** section.
3. Change the default password (0000) of the A40.

Account Login

Contact the corresponding service provider to obtain an account.

Follow the prompts on A40 and CTP25 to sign in to the same account.

11 General Mode (BYOM)

1. Do one of the following to select **General Mode (BYOM)**:
 - When selecting a platform during power-on initialization, select **General Mode (BYOM)**.
 - After logging in, reset to factory to switch platforms.
2. Refer to the **12 Content Sharing and BYOD** section to share content or use the BYOD function.

12 Content Sharing and BYOD (Optional)

Content Sharing

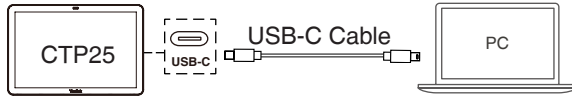

BYOD

Go to the web interface, and enter **System** > **UC Provider** to enable **BYOD Enable**.

Use the USB-C cable to connect the CTP25 to the PC, and follow the prompts to enter BYOD mode.

13 Update the Firmware

Auto Update

Do one of the following:

- During power-on initialization, turn on **Auto Update**.
- In settings, turn on **Auto Update**.

Manual Update

Update the firmware of MeetingBar A40 and CTP25 separately.

1. Obtain the IP address.
2. Open a web browser and enter the device's IP address in the address bar. For example, <https://10.82.24.11/>, and press **Enter**.
3. Enter the administrator username and the password, and click **Login**. (The default user name is "admin", the password is "0000").
4. Go to **System** > **Update**.
5. On the right side of **Device Firmware**, click **Select File** to upload the desired firmware.
6. Click **Update**.

Please get the latest firmware at <https://support.yealink.com/>.

1 Packungsinhalt



MeetingBar A40

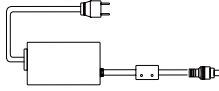

Netzteil
(48 V/1.36 A)
(3.5 m, 11.48 ft)

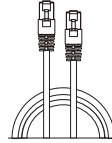

CAT5e UTP
(RJ45 - RJ45) Kabel
(3 m, 9.84 ft)



HDMI 2.0 Kabel
(1.8 m, 5.91 ft)

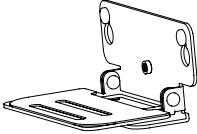

Halterung



Schraube
6 x 30 mm, Weiß,
Polyamid



Schraube
T4 x 30 mm, FA-
HOZN3+



Schraube
1/4 Zoll x 12 mm



Schraube
1/4 Zoll x 13 mm

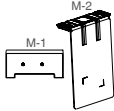

TV-Clip-Halterung



Schraube
1/4 Zoll x 8 mm



Klettverschluss
(Einer ist auf der M-2)

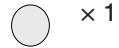

Silikonpad
(38 x T1.2 mm)

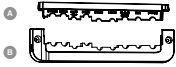

Kabelabdeckung



Schraube
M2 x 4 mm, CM-
H0ZN3+



Kabelbinder
(20 x 200 mm)



Kurzanzleitung

Optionale Pakete

A



VCR11 and
AAA Batterie x 2

B

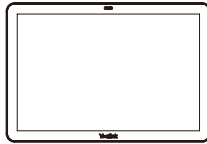

CTP25 Paket

C

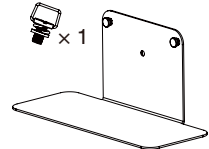

Tischständer

D



Wir empfehlen Ihnen, diese drei Zubehörteile zusammen zu verwenden.



MeetingDisplay
65/75/86

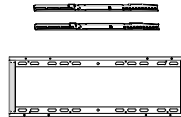

MD-Wallmount

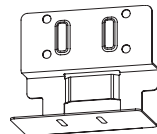

MD-AVBracket-S



Wir empfehlen, dass Sie das mitgelieferte Zubehör oder Zubehör verwenden, das von Yealink genehmigt wurde. Die Verwendung von nicht zugelassenem Zubehör von Drittanbietern kann zu Leistungseinbußen führen.

2 Hardware-Schnittstellenanleitungen

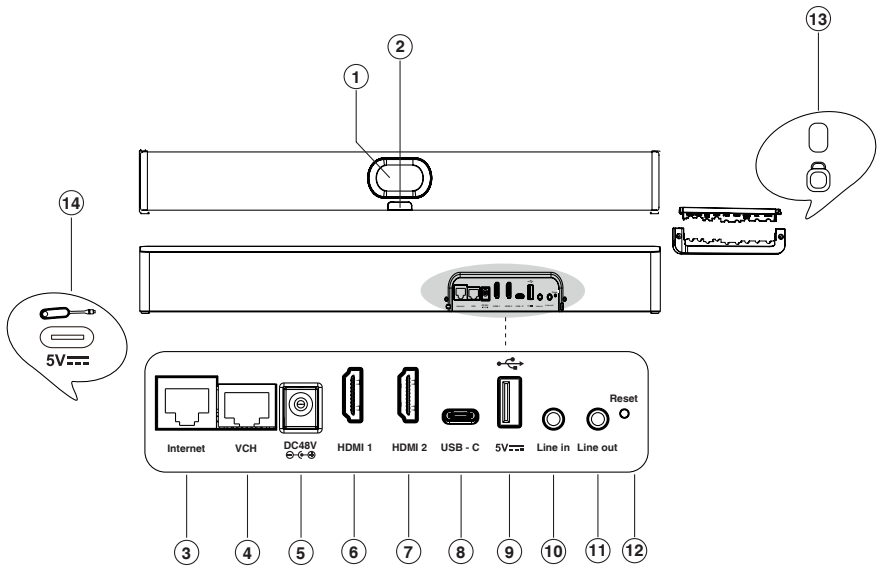

Nein.	Artikel	Beschreibung
1	Kamera	Kamera mit einem elektrischen Sichtschutz.
2	LED-Anzeige	Gerätestatus anzeigen.
3	Internet	<ul style="list-style-type: none"> • Verbinden Sie mit dem LAN-Port eines Yealink MeetingDisplay, um Zugang zum Netzwerk zu erhalten, vorausgesetzt, dass der MeetingDisplay mit dem Internet verbunden ist. • Verbinden Sie sich direkt mit dem Netzwerk, um Internetzugang zu erhalten.
4	VCH	<ul style="list-style-type: none"> • Verbinden Sie sich mit einem Yealink CTP Touch Panel. • Mit einem Mikrofon verbinden. • Mit einem PoE-Switch verbinden.
5	DC48V	Schließen Sie ein Netzteil an.
6, 7	HDMI 1 & HDMI 2	<ul style="list-style-type: none"> • Mit einem Display für die Videoausgabe verbinden. • Sie müssen zuerst den HDMI 1-Anschluss verwenden, wenn Sie nur einen Bildschirm verwenden.

8	USB-C 3.0 (back)	USB-C 3.0 (Rückseite)
9	USB-A 2.0	<ul style="list-style-type: none"> • Verbinden Sie sich mit einem Yealink MeetingDisplay, um die Konfigurationen zu synchronisieren und die Funktionen zu integrieren. • Verbinden Sie ein USB-Zubehörteil, wie z. B. eine Maus.
10, 11	Line-in/Line-out	Verbinden Sie ein Audioausgabe-/Eingabegerät über ein 3,5-mm-Audiokabel.
12	Zurücksetzen-Schlüssel	Auf Werkseinstellungen zurücksetzen.
13	Sicherheitssteckplatz	Verbinden Sie ein universelles Sicherheitskabel mit dem Gerät, damit Sie es sichern können.
14	USB-C 3.0 (Seite)	Connect to a Yealink Wireless Presentation Pod for pairing.

3 Grundlegende Verbindung



- Anzeigeanforderung: Eine Auflösung von 1080p oder höher und ein Anschluss, der HDMI 1.4 oder höher unterstützt.
- Wenn Sie nur ein Display verwenden müssen, schließen Sie es an den HDMI 1-Anschluss an.

MeetingBar A40

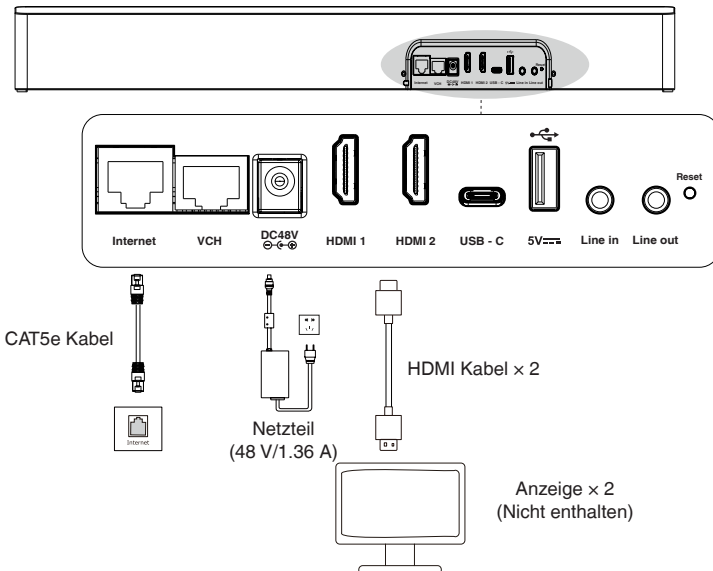

4 Verbinden Sie MeetingDisplay mit A40 (Optional)

- Im Paket von MD-AVBracket-S ist ein USB 2.0 (A - B)-Kabel enthalten.
- Wenn das CAT5e-Kabel von der MeetingBar A40 nicht mit dem LAN-Anschluss des MeetingDisplays verbunden ist, sollte es stattdessen mit einem externen Netzwerkanschluss verbunden werden.

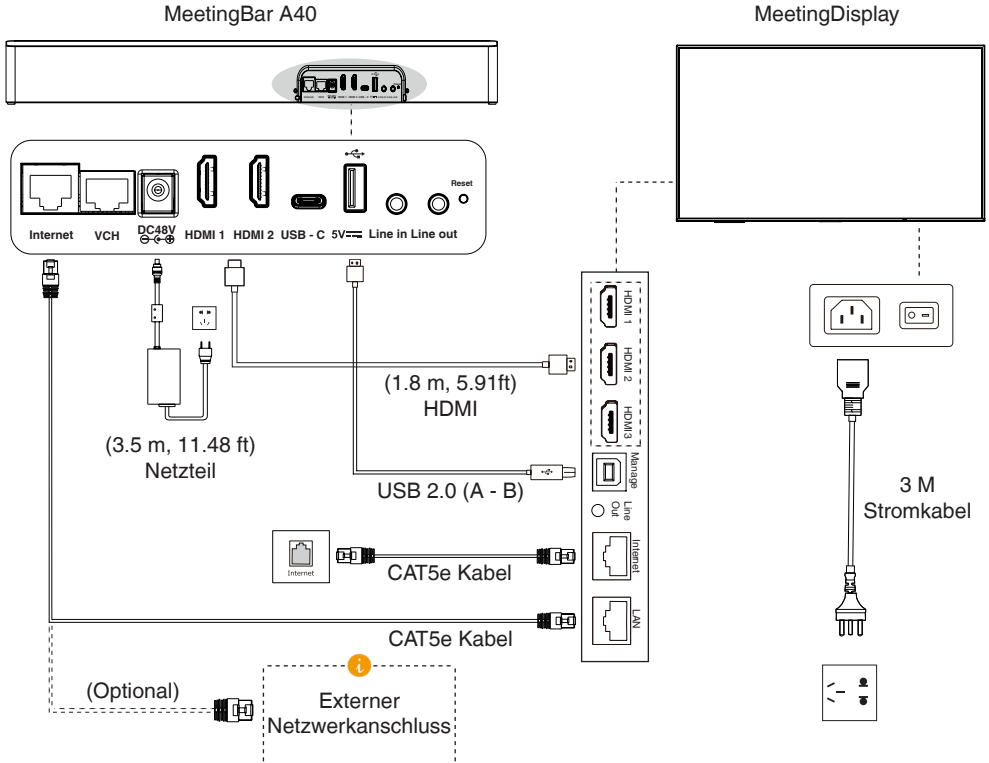

5 Verbinden Sie CTP25 mit A40 (Optional)

Option 1: Direkte Verbindung mit einem Ethernet-Kabel

Verwenden Sie ein Netzwerkkabel, um das CTP25 mit dem A40 zu verbinden.

MeetingBar A40

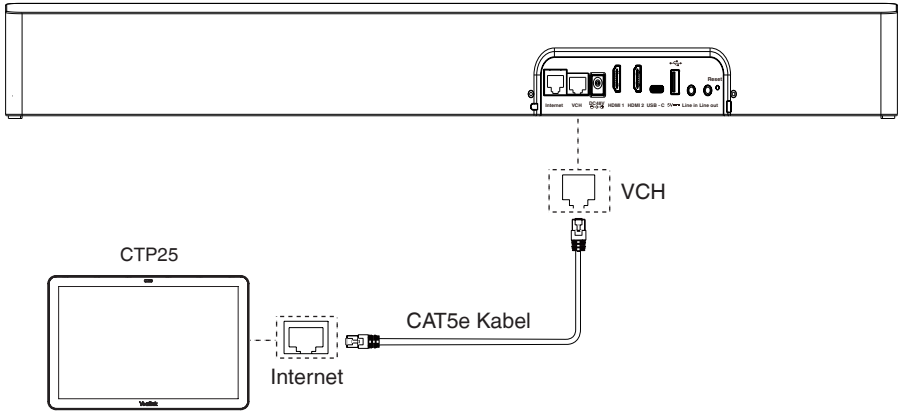

Option 2: Verbindung im selben LAN



A40 und CTP25 müssen im selben LAN sein.

MeetingBar A40

Auf demselben lokalen Netzwerk (LAN)

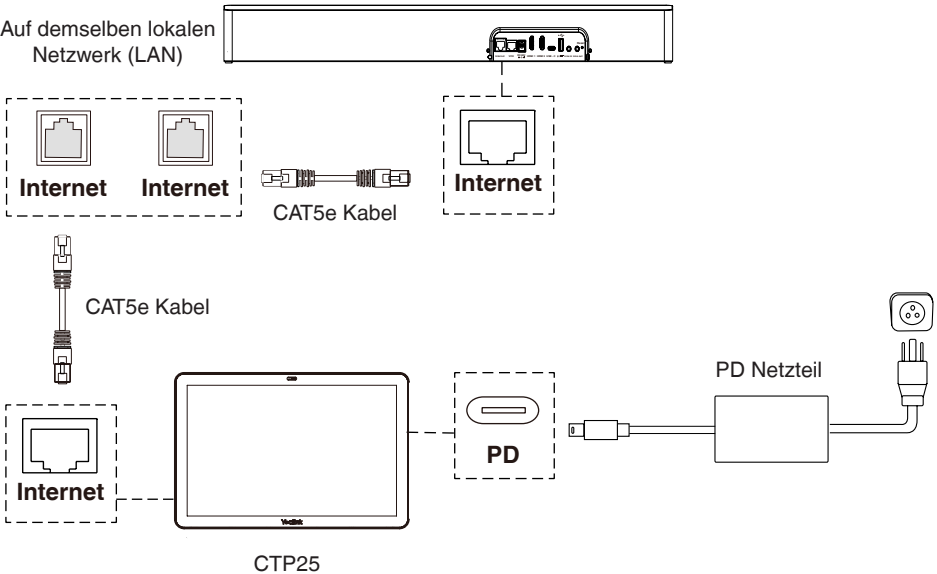

6 Kabelkanalabdeckung Zusammenbauen

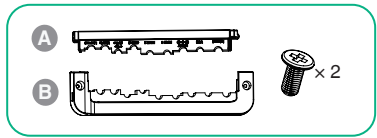

- 1 Finde die beiden Steckplätze auf der Rückseite des A40.

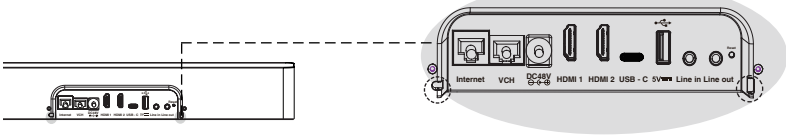

- 2 Passen Sie den Teil A der Kabelabdeckung in die Schlitzte ein.

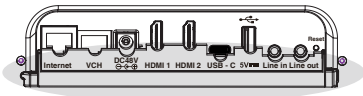

- 3 Bauen Sie Teil B zusammen und befestigen Sie die Schrauben.

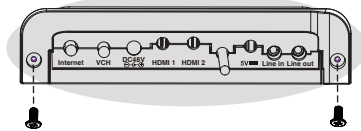

7 Die Installation

Option 1: Befestigen Sie es an dem Yealink MeetingDisplay



Installationsvideo

1

- Sie müssen das MeetingDisplay und das MD-AVBracket-S separat erwerben. Bei der Installation beziehen Sie sich bitte auf den **Schnellstartleitfaden für das MD-AVBracket-S**, der in der entsprechenden Verpackung enthalten ist.
- Zusätzlich sind sechs Schrauben (1/4 Zoll x 12 mm) in der Verpackung des MD-AVBracket-S enthalten.

MeetingDisplay

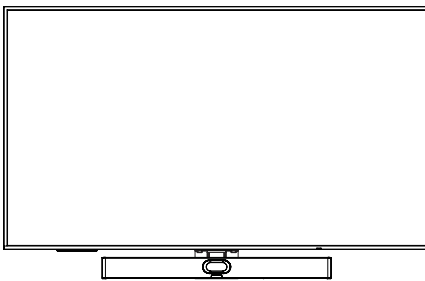

MeetingBar A40

MeetingDisplay

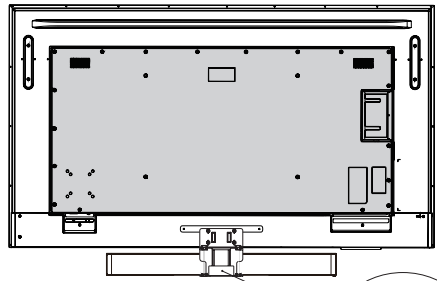

MeetingBar A40

MD-AVBracket-S

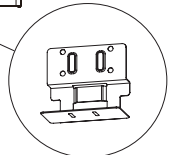

Option 2: An einer Wand Montieren

Schritt 1: Bestimmen Sie die Position von A40

Die Montagehöhe beeinflusst die Kameraperspektive. Die empfohlene Installationshöhe beträgt 110 cm über dem Boden, und der freigehaltene Abstand zwischen A40 und Fernseher sollte größer als 1 cm sein.

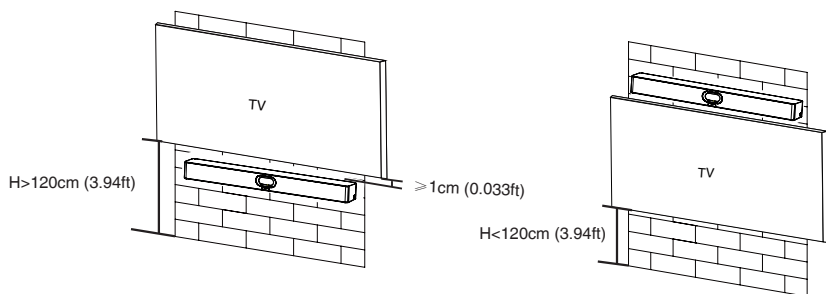

Schritt 2: Befestigen Sie den A40 an der Wand.

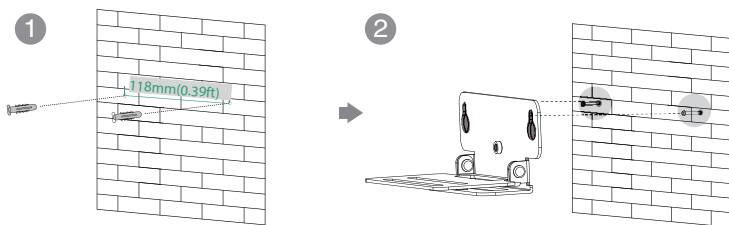
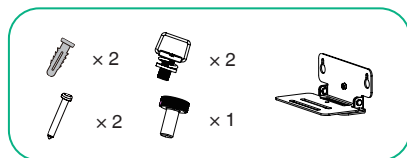

Lochtiefe: 30 mm (0.098ft) Lochdurchmesser: 6 mm (0.02ft)

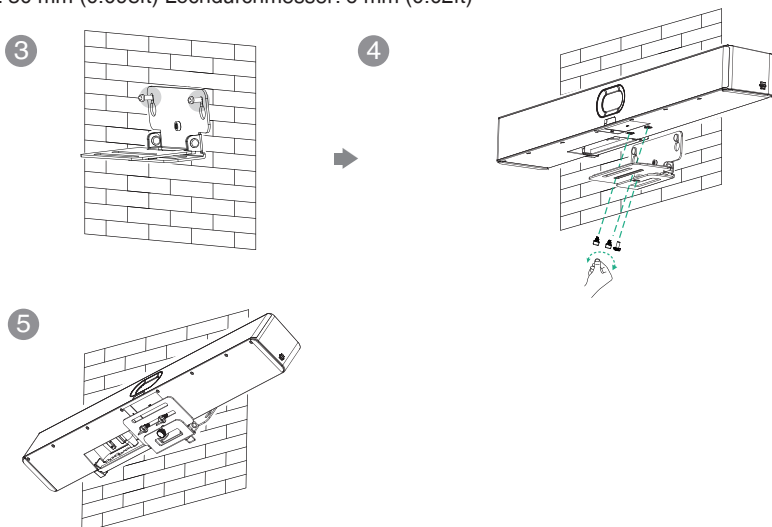

Option 3: Montieren Sie über einem Fernseher oder einem Bildschirm



- Die M-2 Halterung kann in die M-1 in zwei Richtungen eingesetzt werden. Hier werden wir uns auf eine Richtung zur Veranschaulichung konzentrieren.
- Aufgrund des Gewichts des Geräts ist es ratsam, das Gerät nicht an schlanken Fernsehern zu montieren, um mögliche Stürze oder Schäden am Bildschirm zu vermeiden.

1

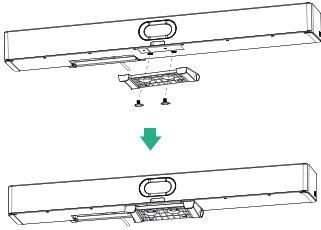

3

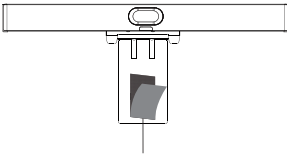

Klettverschluss A ist standardmäßig auf der Innenseite von M-2 angebracht.

2

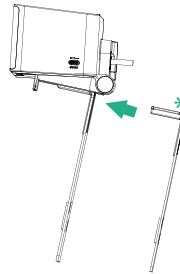

Achten Sie auf die Richtung der M-2.

4

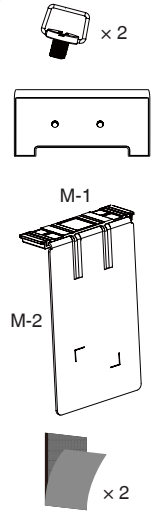
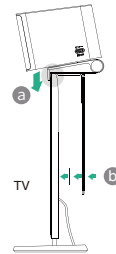

Option 4: Legen Sie es auf eine Ebene Fläche

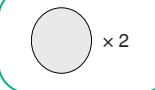

Auf dem Schreibtisch

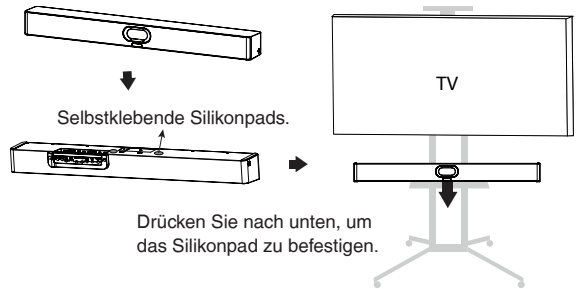

Auf dem TV-Ständerwagen-Plattform (einzeln kaufen)

Option 5: In die Wand Einbetten



- Die Montagehöhe beeinflusst die Kameraperspektive. Die empfohlene Einbauhöhe beträgt 110 cm über dem Boden.
- Halten Sie die Vorderseite des A40 bündig mit der Wandoberfläche.
- Die empfohlene Entfernung an den linken, rechten und oberen Seiten des A40 beträgt weniger als 0.5 cm.
- Lassen Sie einen Abstand von 5 ± 0.5 cm zwischen der Rückseite des A40 und der Wandfläche für Kabelverbindungen.

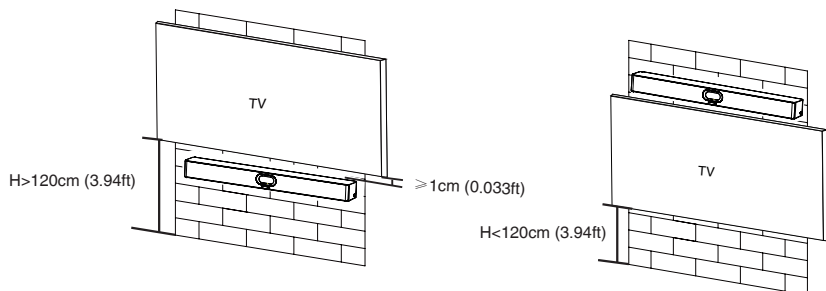

Option 6: Montieren Sie auf dem Tischständer



Beziehen Sie sich auf den Abschnitt **8 Kameraneigung Anpassen** für die Halterungseinstellung.

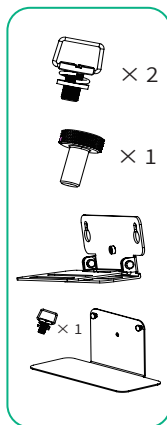
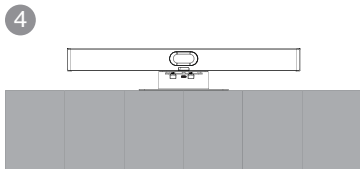
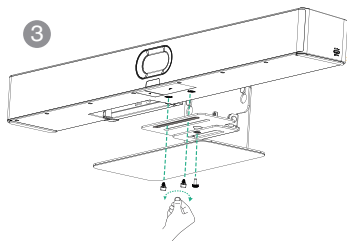
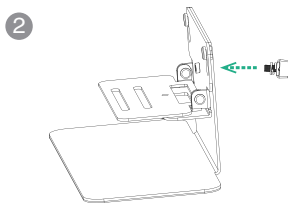
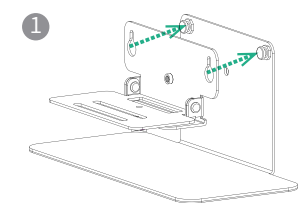

8 Kameraneigung Anpassen

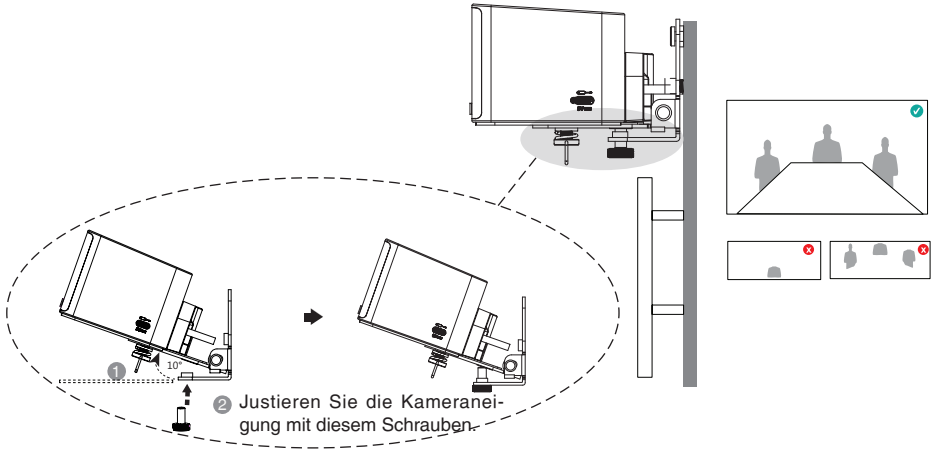

9 VCR11 (Optional)

1

Sie können die Fernbedienung (nicht anwendbar auf die Zoom-Version) oder CTP25 verwenden, um den A40 zu bedienen. Wenn ein Touch-Display-Gerät angeschlossen ist, können Sie den A40 auch direkt über den Touchscreen bedienen.

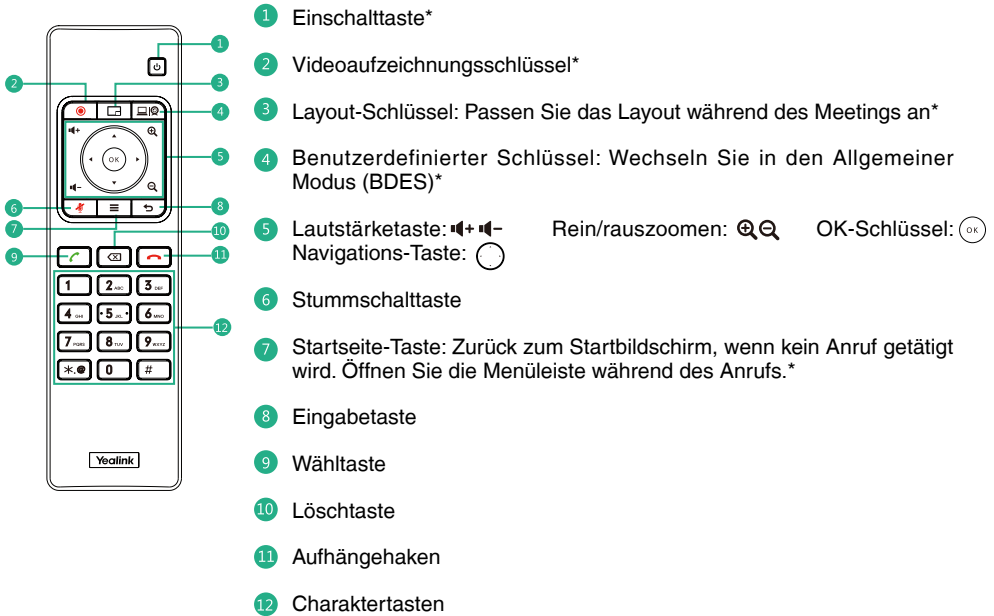

* Demnächst verfügbar



Die unterstützten Tasten in verschiedenen Modi können unterschiedlich sein.

10 Paar mit dem CTP25 (Optional)

Für ein besseres Pairing-Erlebnis empfehlen wir, zuerst den A40 und dann den CTP25 zu starten.

Paar manuell

Wenn Sie ein Bundle-Kit erworben oder CTP25 über ein Netzwerkkabel mit A40 verbunden haben, werden A40 und CTP25 automatisch gekoppelt. Sie können direkt zur **Initialisierung** gehen.

Geben Sie auf dem CTP25 die IP-Adresse und den Kopplungscode des A40-Displays ein.

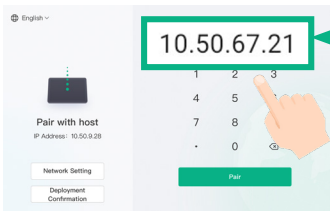

CTP25

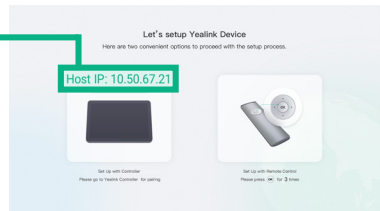

MeetingBar A40

Initialisierung

1. Wenn der CTP25 auf die Werkseinstellungen zurückgesetzt wird, müssen Sie das Standardpasswort (0000) des CTP25 ändern.
2. Initialisiere die **Sprache**, das **Netzwerk**, die **Zeitzone** und die **automatische Aktualisierung** und wähle die gewünschte Plattform aus. Wenn Sie den Allgemeiner Modus (BDES) auswählen, beachten Sie bitte den Abschnitt **11 Allgemeiner Modus (Bring deine eigene Sitzung)**.
3. Ändern Sie das Standardpasswort (0000) des A40.

Kontoanmeldung

Folgen Sie den Aufforderungen auf A40 und CTP25, um sich bei demselben Konto anzumelden.

Kontaktieren Sie den entsprechenden Dienstleister, um ein Konto zu erhalten.

11 Allgemeiner Modus (Bring deine eigene Sitzung)

1. Wählen Sie eine der folgenden Optionen aus, um den **Allgemeiner Modus (BDES)** auszuwählen:
 - Beim Auswählen einer Plattform während der Power-On-Initialisierung wählen Sie den **Allgemeiner Modus (BDES)**.
 - Nach dem Einloggen auf die Werkseinstellungen zurücksetzen, um die Plattform zu wechseln.
2. Informationen zum Teilen von Inhalten oder zur Verwendung der BYOD-Funktion finden Sie im Abschnitt **12 Inhaltsfreigabe und BYOD**.

12 Inhaltsfreigabe und BYOD (optional)

Inhaltsfreigabe

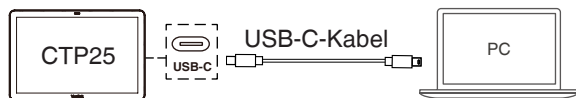

BYOD

Gehe zur Weboberfläche und gib **System > UC-Anbieter** ein, um BYOD zu aktivieren.

Verwenden Sie das USB-C-Kabel, um den CTP25 mit dem PC zu verbinden, und befolgen Sie die Anweisungen, um in den BYOD-Modus zu wechseln.

13 Aktualisieren Sie die Firmware

Automatische Aktualisierung

Befolgen Sie eine der folgenden Anweisungen:

- Aktivieren Sie während der Initialisierung des Einschaltens die **automatische Aktualisierung**.
- In den Einstellungen die **automatische Aktualisierung** aktivieren.

Manuelles Update

Aktualisieren Sie die Firmware von MeetingBar A40 und CTP25 separat.

1. IP-Adresse abrufen.
2. Öffnen Sie einen Webbrowser und geben Sie die IP-Adresse des Geräts in die Adressleiste ein. Beispiel: <https://10.82.24.11/>, und drücken Sie die **Eingabetaste**.
3. Geben Sie den Benutzernamen und das Kennwort des Administrators ein und klicken Sie auf Anmelden. (Der Standardbenutzername ist "admin", das Kennwort lautet "0000").
4. Wechseln Sie zu **System > Update**.
5. Klicken Sie auf der rechten Seite der **Geräte-Firmware** auf **Datei auswählen**, um die gewünschte Firmware hochzuladen.
6. Klicken Sie auf **Aktualisieren**.

Bitte laden Sie die aktuellste Firmware hier herunter: <https://support.yealink.com/>

1 Contenu du Paquet



MeetingBar A40

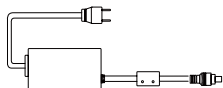

Adaptateur Secteur
(48 V/1.36 A)
(3.5 m, 11.48 ft)

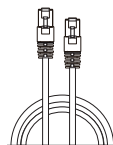

CAT5e UTP
(RJ45 - RJ45) Câble
(3 m, 9.84 ft)



HDMI 2.0 Câble
(1.8 m, 5.91 ft)

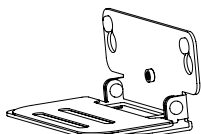

Support de Fixation

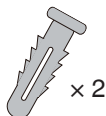

Vis
6 x 30 mm, White,
Polyamide



Vis
T4 x 30 mm, FA-
HOZN3+



Vis
1/4 inch x 12 mm



Vis
1/4 inch x 13 mm

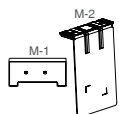

Support TV-Clip



Vis
1/4 inch x 8 mm



Velcro
(Un est sur la M-2)



Support en Silicone
(38 x T1.2 mm)



Cache-câble



Vis
M2 x 4 mm, CM-
HOZN3+



Serre-Câbles
(20 x 200 mm)



Guide de Démarrage
Rapide

Paquets Optionnels

A



VCR11 and
Pile AAA x 2

B



Forfait CTP25

C

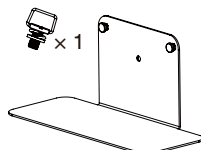

Support de Table

D

Wir empfehlen Ihnen, diese drei Zubehörteile zusammen zu verwenden.



MeetingDisplay
65/75/86

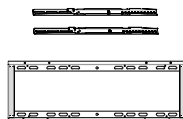

MD-Wallmount

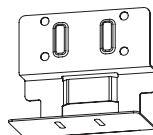

MD-AVBracket-S

Nous vous recommandons d'utiliser les accessoires fournis ou approuvés par Yealink. L'utilisation d'accessoires tiers est susceptible de réduire les performances de l'appareil.

2 Instructions d'Interface Matérielle

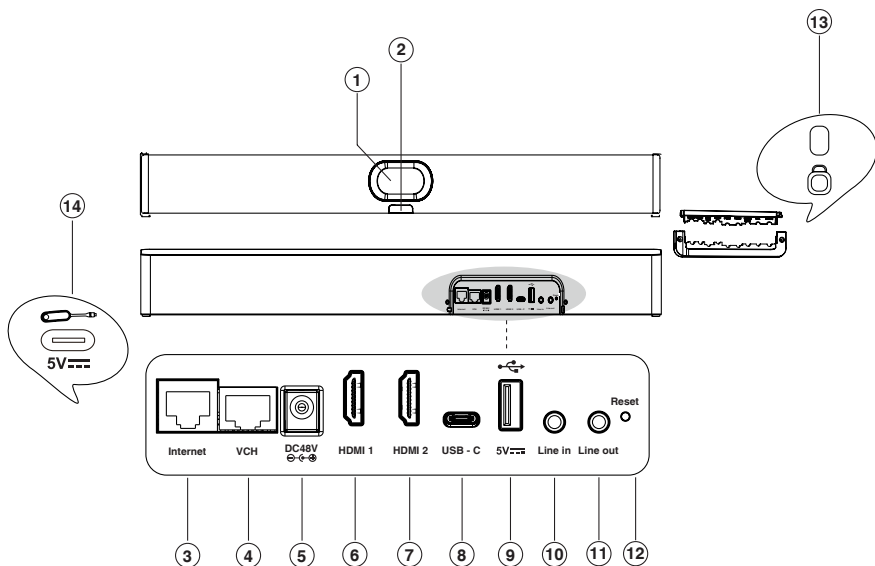

Non.	Article	Description
1	Caméra	Caméra avec un obturateur de confidentialité électrique.
2	Indicateur LED	Indiquez l'état de l'appareil.
3	Internet	<ul style="list-style-type: none"> • Verbinden Sie sich mit dem LAN-Port eines Yealink MeetingDisplays, um sich mit dem Netzwerk zu verbinden, vorausgesetzt, dass das MeetingDisplay mit dem Internet verbunden ist. • Verbinden Sie sich direkt mit dem Netzwerk, um Zugang zum Internet zu erhalten.
4	VCH	<ul style="list-style-type: none"> • Connectez-vous à un panneau tactile Yealink CTP. • Connectez-vous à un microphone. • Connectez-vous à un switch PoE.
5	DC48V	Connectez-vous à un adaptateur secteur.
6, 7	HDMI 1 ET HDMI 2	<ul style="list-style-type: none"> • Connectez-vous à un écran pour la sortie d'image vidéo. • Vous devez utiliser le port HDMI 1 en premier lorsque vous utilisez un seul écran.

8	USB-C 3.0 (arrière)	Connectez-vous à un PC pour le partage de contenu ou BYOD.
9	USB-A 2.0	<ul style="list-style-type: none"> • Verbinden Sie sich mit einem Yealink MeetingDisplay, um die Einstellungen zu synchronisieren und die Funktionen zu integrieren. • Verbinden Sie ein USB-Zubehörteil, wie beispielsweise eine Maus.
10, 11	Entrée/sortie ligne	Connectez-vous à un périphérique audio d'entrée/sortie via un câble audio de 3,5 mm.
12	Réinitialiser la clé	Réinitialiser aux paramètres d'usine.
13	Fente de sécurité	Connectez un câble de sécurité universel à l'appareil afin de pouvoir le verrouiller.
14	USB-C 3.0 (côté)	Connectez-vous à un pod de présentation sans fil Yealink pour le couplage.

3 Connexion de Base



- Exigence d'affichage : Une résolution de 1080p ou supérieure, et un port compatible avec HDMI 1.4 ou supérieur.
- Si vous n'utilisez qu'un seul écran, veuillez vous connecter au port HDMI 1.

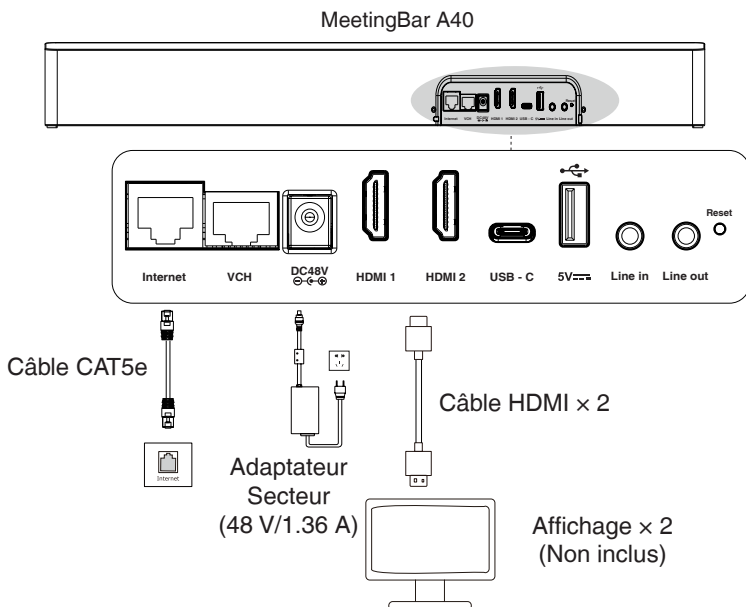

4 Connectez le MeetingDisplay au A40 (optionnel)

- Un câble USB 2.0 (A-B) est inclus dans le paquet du MD-AVBracket-S.
- Si le câble CAT5e provenant de la MeetingBar A40 n'est pas connecté au port LAN du MeetingDisplay, il doit alors être connecté à un port réseau externe.

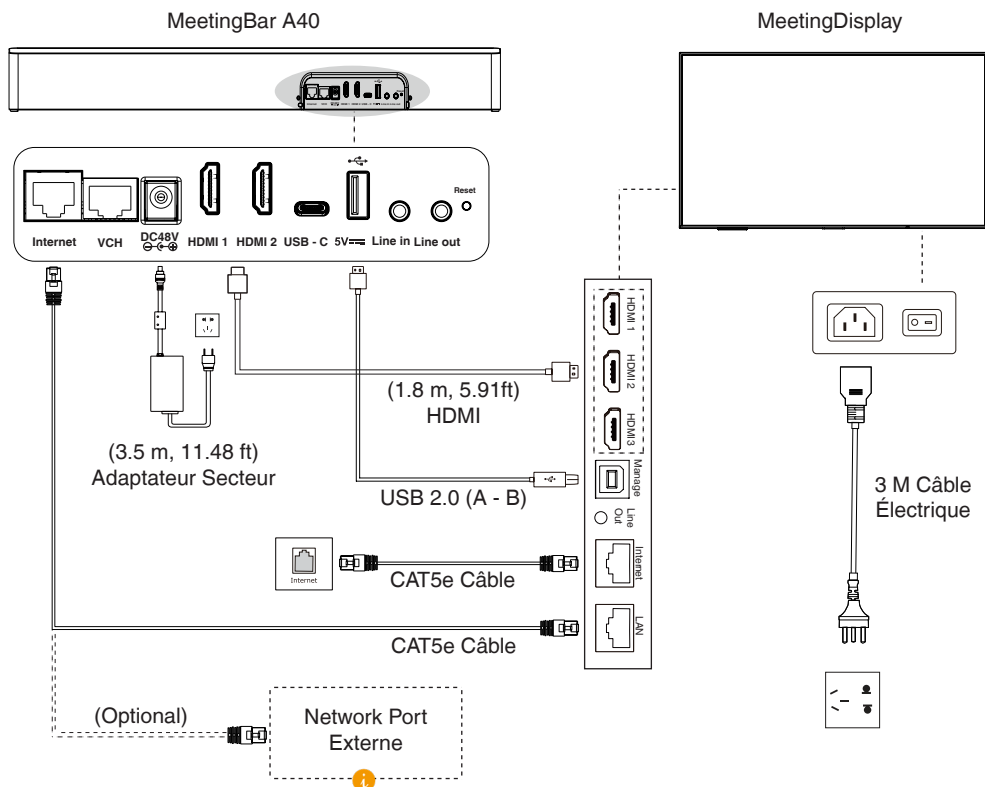

5 Connectez le CTP25 au A40 (optionnel)

Option 1 : Connexion Directe Avec un Câble Ethernet

Utilisez un câble réseau pour connecter le CTP25 à l'A40.

MeetingBar A40

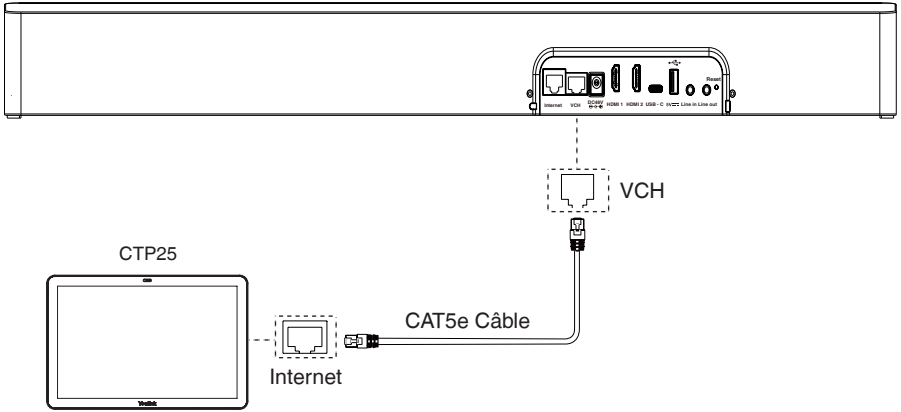

Option 2 : Connexion sur le Même Réseau Local



A40 et CTP25 doivent être sur le même réseau local (LAN).

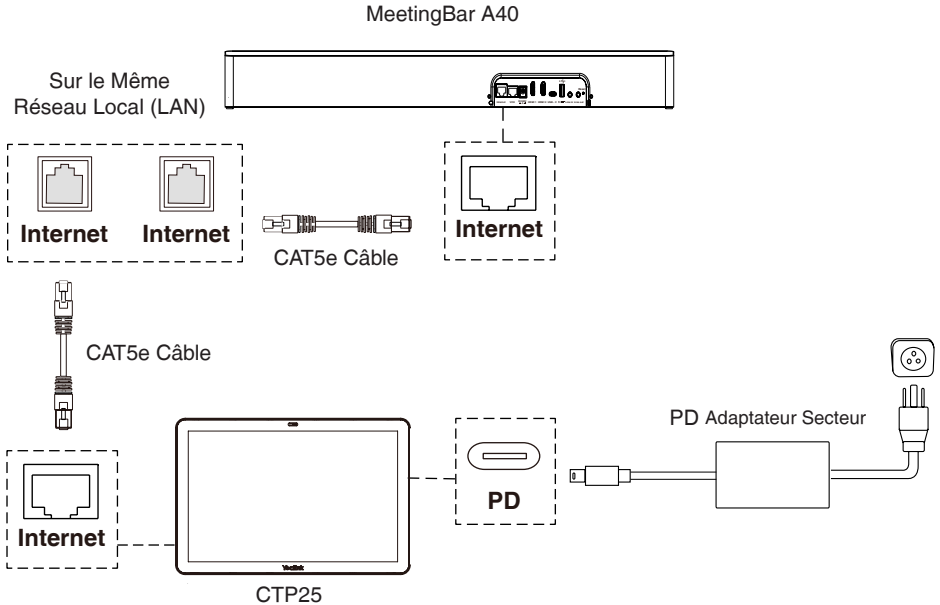

6 Assemblez le Couvercle du Câble

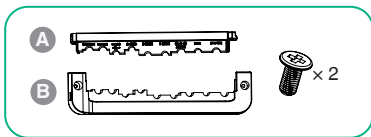

1 Trouvez les deux fentes à l'arrière de l'A40.

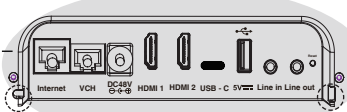
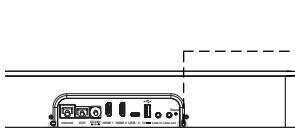

2 Insérez la partie A du cache-câble dans les fentes.

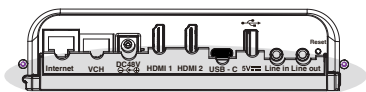

3 Assembler la pièce B et fixer les vis.

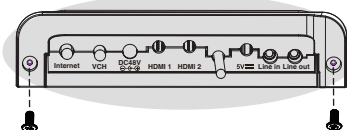

7 Installation

Option 1: Se Connecter au Yealink MeetingDisplay



Vidéo d'Installation



- Vous devez acheter séparément le MeetingDisplay et le support MD-AVBracket-S de Yealink. Pour l'installation, veuillez vous référer au [Guide De Démarrage Rapide du Support MD-AVBracket-S](#) inclus dans l'emballage correspondant.
- Six vis supplémentaires (1/4 pouce × 12 mm) sont également incluses dans l'emballage du support MD-AVBracket-S.

MeetingDisplay

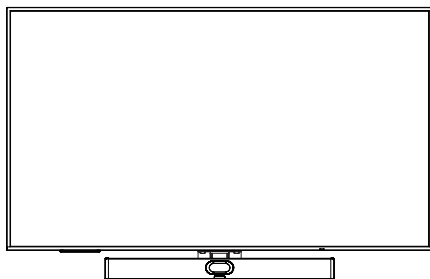

MeetingBar A40

MeetingDisplay

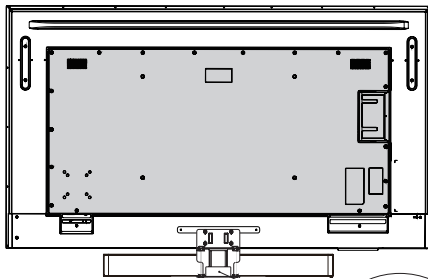

MeetingBar A40

MD-AVBracket-S

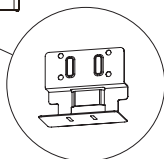

Option 2: Fixer au Mur

Étape 1 : Déterminez la position de A40

La hauteur de montage affecte la vue de votre caméra. La hauteur d'installation recommandée est de 110 cm au-dessus du sol, et la distance réservée entre A40 et la télévision doit être supérieure à 1 cm.

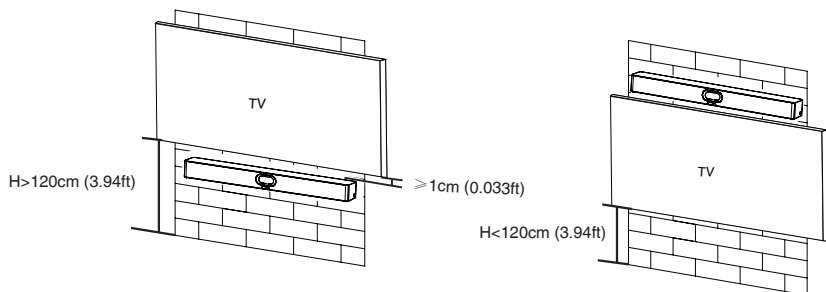

Étape 2 : Fixez le A40 au mur.

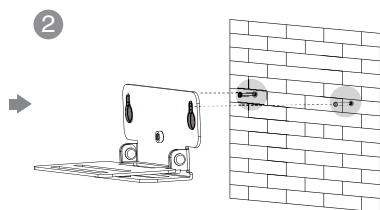
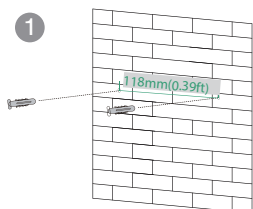
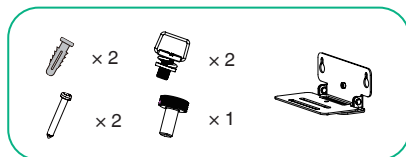

Hole depth: 30 mm (0.098ft) Hole diameter: 6 mm (0.02ft)

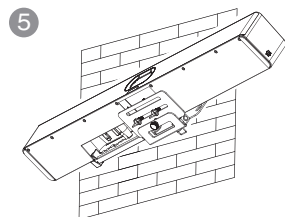
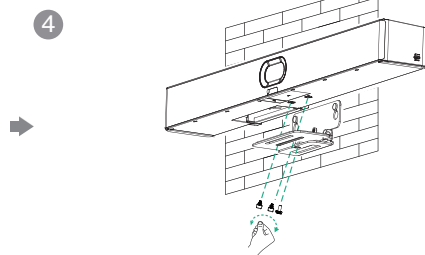
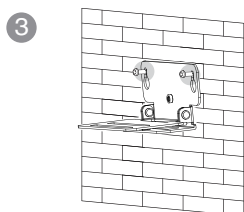

Option 3: Montez Au-dessus d'une Télévision ou d'un Écran



- La bride M-2 peut être insérée dans la bride M-1 dans deux directions. Ici, nous nous concentrerons sur une direction pour l'illustration.
- En raison du poids de l'appareil, il est conseillé d'éviter de monter l'appareil sur des téléviseurs minces pour éviter les chutes potentielles ou les dommages à l'écran.

1

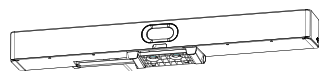
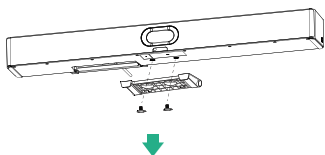

3

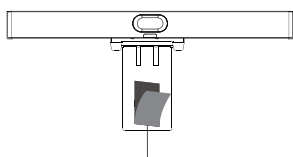

Le Velcro A est fixé à l'intérieur de M-2 par défaut.

2

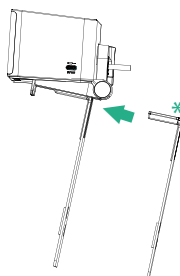

Faites attention à la direction de la M-2

4

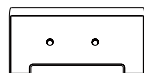
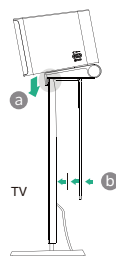

M-1

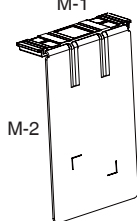

M-2



Option 4: Mettez sur une Surface Plane

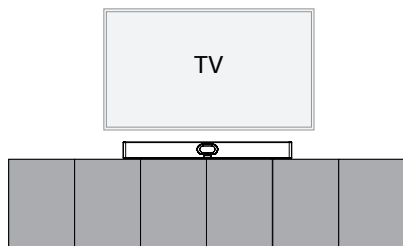

Sur le bureau

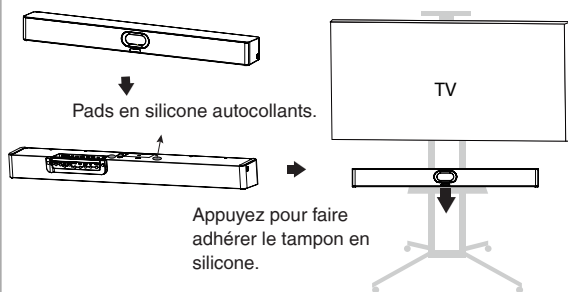

Sur le plateau du meuble TV.
(acheter séparément)

Option 5: Encastrer dans le Mur



- La hauteur de montage affecte la vue de votre caméra. La hauteur d'installation recommandée est de 110 cm au-dessus du sol.
- Maintenez l'avant de l'A40 au ras de la surface du mur.
- La marge recommandée sur les côtés gauche, droit et supérieur de l'A40 est inférieure à 0.5 cm.
- Laissez une distance de 5 ± 0.5 cm entre l'arrière de l'A40 et la surface du mur pour les connexions de câbles.

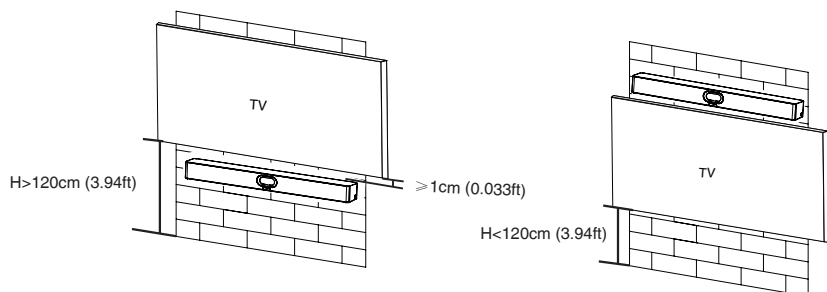

Option 6: Montez sur le Support de Table



Référez-vous à la section **8 Ajustez L'inclinaison de la Caméra** pour l'ajustement du

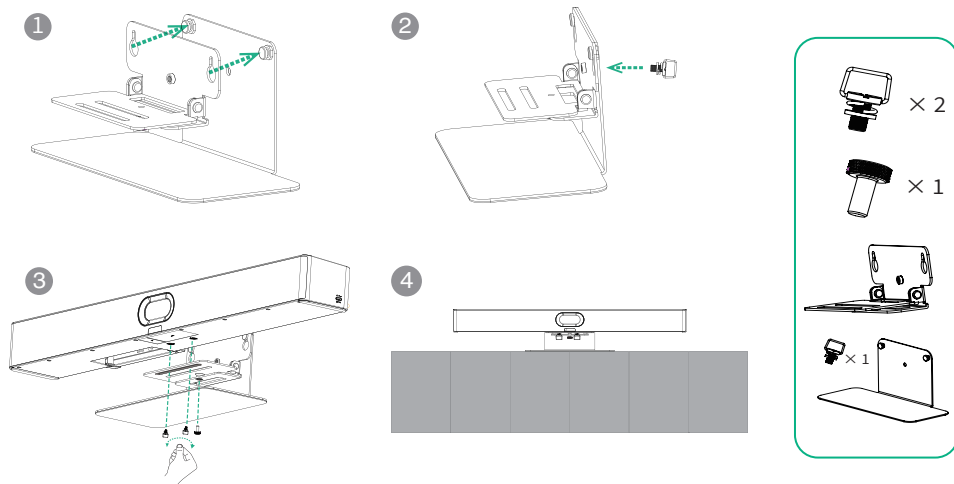

8 Ajustez L'inclinaison de la Caméra

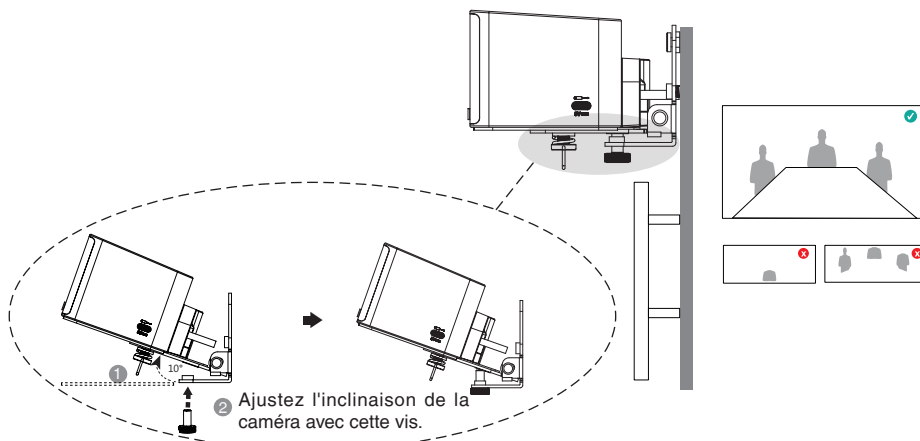

9 VCR11 (Optionnel)

Vous pouvez utiliser la télécommande (non applicable à la version Zoom) ou le CTP25 pour faire fonctionner l'A40. Si un appareil à écran tactile est connecté, vous pouvez également utiliser l'A40 directement sur l'écran tactile.

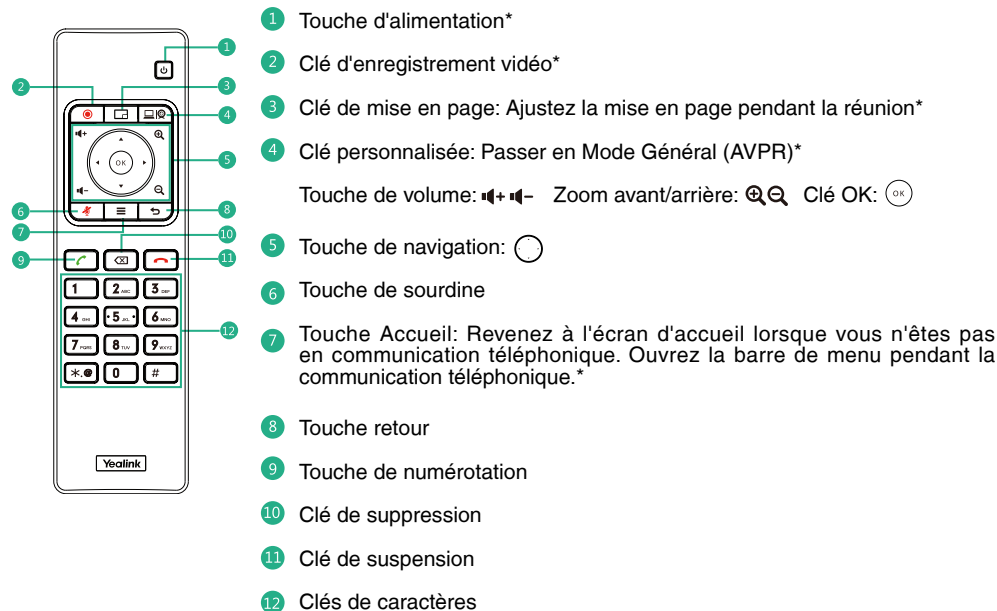

* Bientôt disponible

Les clés supportées dans différents modes peuvent être variées.

10 Paires Avec le CTP25 (Optionnel)

Pour une meilleure expérience d'appariement, nous recommandons de démarrer d'abord l'A40, puis le CTP25.

Paier Manuellement

Si vous avez acheté un kit groupé ou connecté le CTP25 au A40 via un câble réseau, le A40 et le CTP25 seront automatiquement couplés. Vous pouvez accéder directement à l'**initialisation**.

Sur le CTP25, entrez l'adresse IP et le code d'appariement du A40 affiché.

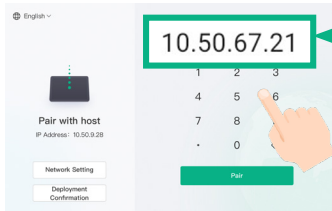

CTP25

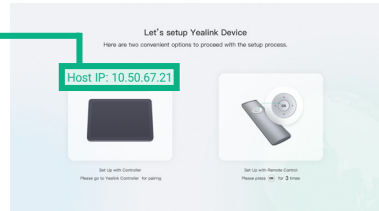

MeetingBar A40

Initialisation

1. Si le CTP25 est restauré aux paramètres d'usine, vous devez changer le mot de passe par défaut (0000) du CTP25.
2. Initialiser la **langue**, le **réseau**, le **fuseau horaire** et la **mise à jour automatique**, et sélectionner la plateforme souhaitée. Si vous sélectionnez le **Mode Général (AVPR)**, reportez-vous à la section **11 Mode Général (Apportez votre propre réunion)**.
3. Changer le mot de passe par défaut (0000) de l'A40.

Connexion au Compte

Contactez le fournisseur de services correspondant pour obtenir un compte.

Suivez les instructions sur A40 et CTP25 pour vous connecter au même compte.

11 Mode Général (Apportez votre propre réunion)

1. Sélectionnez l'un des éléments suivants pour choisir le **Mode Général (AVPR)** :
 - Lors de la sélection d'une plateforme lors de l'initialisation de l'alimentation, choisissez le Mode Général (AVPR).
 - Après vous être connecté, réinitialisez aux paramètres d'usine pour changer de plateforme.
2. Reportez-vous à la section **12 Partage de Contenu et BYOD** pour partager du contenu ou utiliser la fonction BYOD.

12 Partage de Contenu et BYOD (Optionnel)

Partage de Contenu

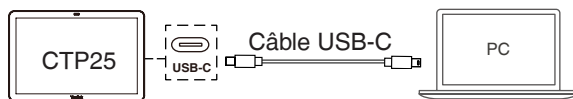

BYOD

Allez à l'interface web, et entrez **Système** > **Fournisseur UC** pour activer BYOD Enable.

Utilisez le câble USB-C pour connecter le CTP25 à l'ordinateur, puis suivez les instructions pour entrer en mode BYOD.

13 Mettre à Jour le Micrologiciel

Mise à Jour Automatique

Effectuez l'une des actions suivantes :

- Pendant l'initialisation au démarrage, activez la mise à jour automatique.
- Dans les paramètres, activez la mise à jour automatique.

Mise à Jour Manuelle

Mettez à jour le micrologiciel du MeetingBar A40 et du CTP25 séparément.

1. Obtenez l'adresse IP.
2. Ouvrez un navigateur Web et saisissez l'adresse IP du périphérique dans la barre d'adresse. Par exemple, <https://10.82.24.11/>, et appuyez sur **Entrée**.
3. Entrez le nom d'utilisateur de l'administrateur et le mot de passe, puis cliquez sur Connexion. Le nom d'utilisateur par défaut est "admin" et le mot de passe est "0000".
4. Allez dans **Système** > **Mise à jour**.
5. Sur le côté droit du **micrologiciel de l'appareil**, cliquez sur **Sélectionner un fichier** pour télécharger le micrologiciel souhaité.
6. Cliquez sur **Mettre à jour**.

Vous pouvez obtenir la dernière version du micrologiciel sur <https://support.yealink.com/>.

1 Contenido del Paquete



MeetingBar A40

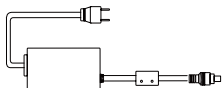

Adaptador de Corriente
(48 V/1.36 A)
(3.5 m, 11.48 ft)

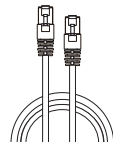

CAT5e UTP
(RJ45 - RJ45) Cable
(3 m, 9.84 ft)

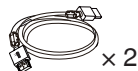

HDMI 2.0 Cable
(1.8 m, 5.91 ft)

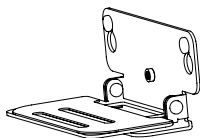

Soporte de Montaje

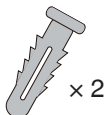

Tornillo
6 x 30 mm, blanco,
Poliamida

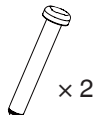

Tornillo
T4 x 30 mm, FA-
HOZN3+



Tornillo
1/4 inch x 12 mm



Tornillo
1/4 inch x 13 mm

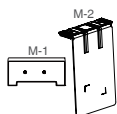

Soporte para
Clip de TV



Tornillo
1/4 inch x 8 mm



Velcro
(Uno está en la M-2)



Bases de Silicona
(38 x 11.2 mm)



Cubierta de Cables



Tornillo
M2 x 4 mm, CM-
HOZN3+



Sujetacables
(20 x 200 mm)



Guía de Inicio Rápido

Paquetes Opcionales

A



VCR11 y
batería AAA x 2

B

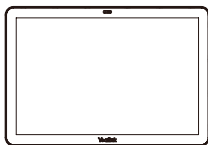

Paquete CTP25

C

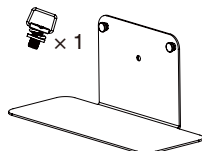

Soporte de Mesa

D

Recomendamos que
utilices estos tres
accesorios juntos.



MeetingDisplay
65/75/86



MD-Wallmount

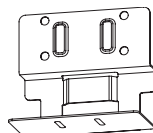

MD-AVBracket-S

Utilice siempre accesorios proporcionados o aprobados por Yealink. El uso de accesorios de terceros no aprobados puede afectar al funcionamiento.

2 Instrucciones de la Interfaz de Hardware

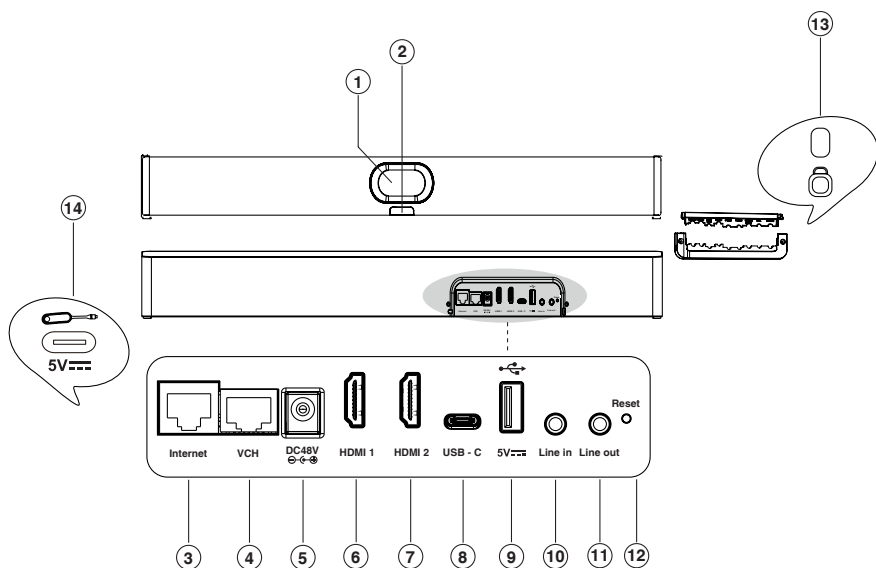

No.	Elemento	Descripción
1	Cámara	Cámara con un obturador de privacidad eléctrico.
2	Indicador LED	Indique el estado del dispositivo.
3	Internet	<ul style="list-style-type: none"> • Conéctate al puerto LAN del MeetingDisplay de Yealink para acceder a la red, siempre y cuando el Meeting Display esté conectado a Internet. • Conéctate directamente a la red para acceder a Internet.
4	VCH	<ul style="list-style-type: none"> • Conéctate a un panel táctil Yealink CTP. • Conéctate a un micrófono. • Conéctate a un switch PoE.
5	DC48V	Conéctate a un adaptador de corriente.
6, 7	HDMI 1 Y HDMI 2	<ul style="list-style-type: none"> • Conéctese a una pantalla para la salida de imagen de video. • Necesitas usar el puerto HDMI 1 primero cuando uses solo una pantalla.

8	USB-C 3.0 (trasero)	Conéctese a una PC para compartir contenido o BYOD.
9	USB-A 2.0	<ul style="list-style-type: none"> • Conéctate a un MeetingDisplay de Yealink para sincronizar las configuraciones e integrar las funcionalidades. • Conecta un accesorio USB, como un ratón.
10, 11	Línea de entrada/Línea de salida	Conéctate a un dispositivo de salida/entrada de audio a través de un cable de audio de 3.5 mm.
12	Restablecer clave	Restablecer a los valores de fábrica.
13	Ranura de seguridad	Conecta un cable de seguridad universal al dispositivo para que puedas bloquearlo.
14	USB-C 3.0 (lateral)	Conéctate a un Pod de Presentación Inalámbrico Yealink para emparejar.

3 Conexión Básica



- Requisito de visualización: Una resolución de 1080p o superior y un puerto que admita HDMI 1.4 o superior.
- Si solo necesita usar una pantalla, conéctela al puerto HDMI 1.

MeetingBar A40

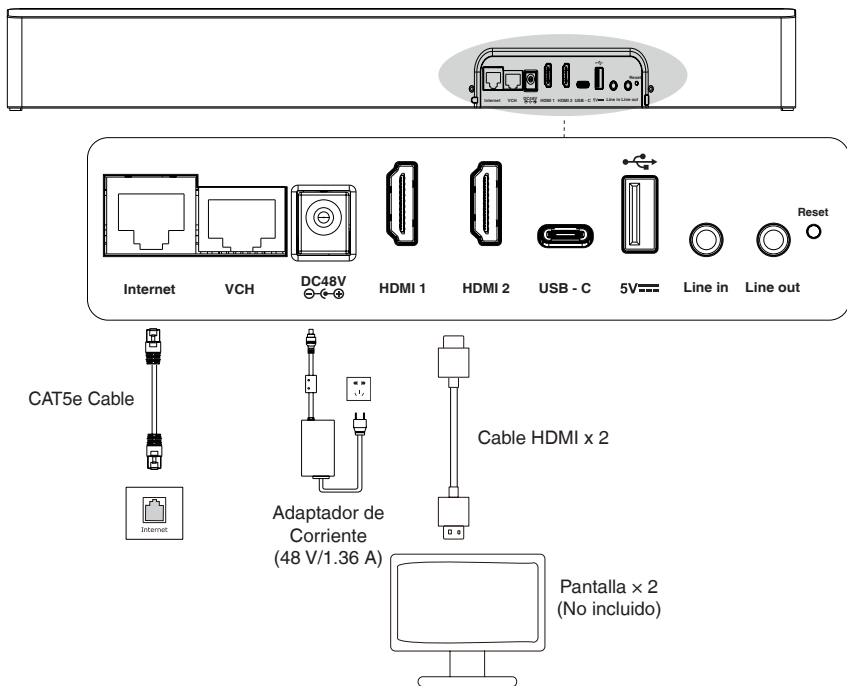

4 Conecta MeetingDisplay con A40 (Opcional)

- El cable USB 2.0 (A-B) está incluido en el paquete del MD-AVBracket-S.
- Si el cable CAT5e de la MeetingBar A40 no está conectado al puerto LAN del MeetingDisplay, entonces debe conectarse a un puerto de red externo.

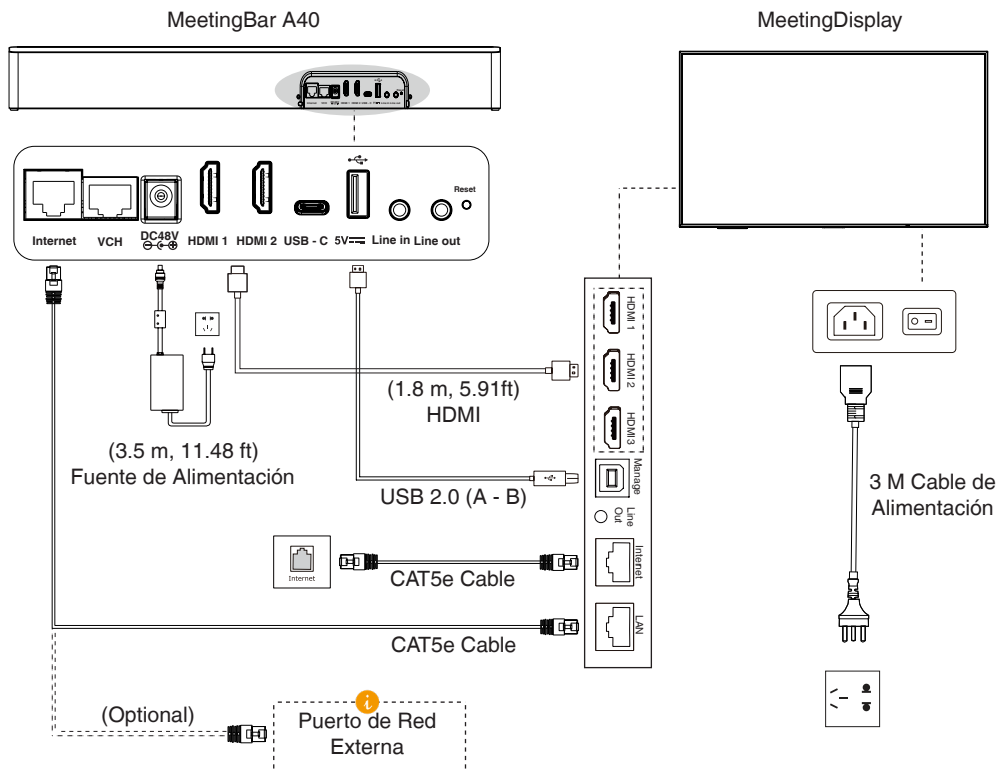

5 Conecta CTP25 con A40 (Opcional)

Opción 1: Conexión Directa Con un Cable Ethernet

Utilice un cable de red para conectar el CTP25 al A40.

MeetingBar A40

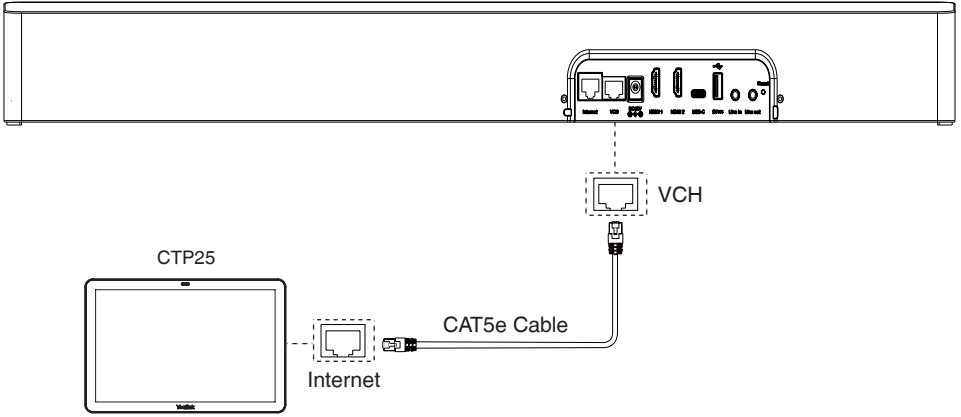

Opción 2: Conexión en la Misma LAN

A40 y CTP25 necesitan estar en la misma LAN.

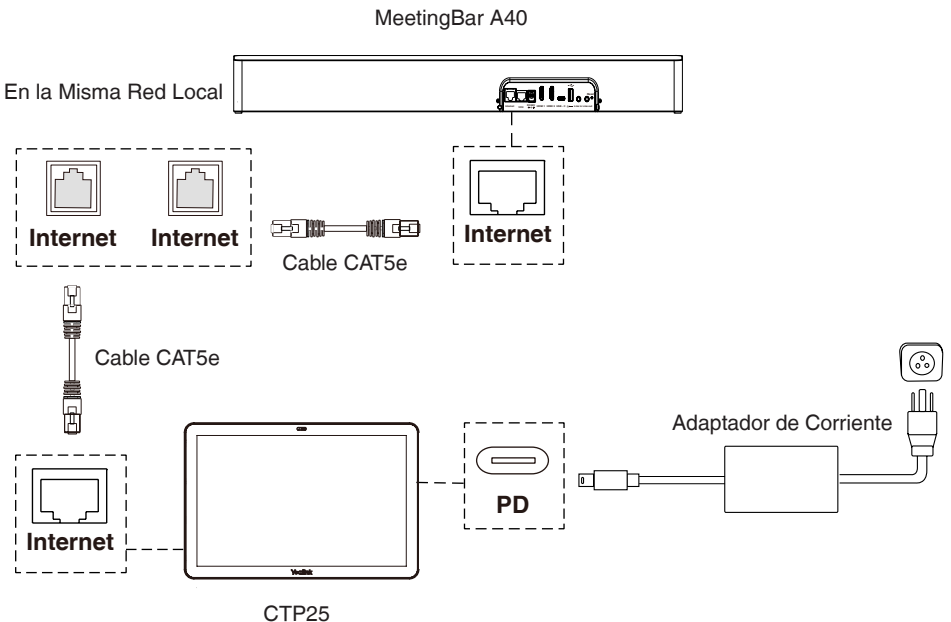

6 Ensamblar la Cubierta del Cable

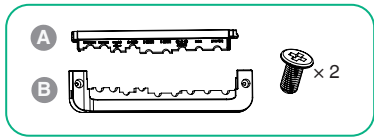

1 Encuentra los dos ranuras en la parte posterior del A40.

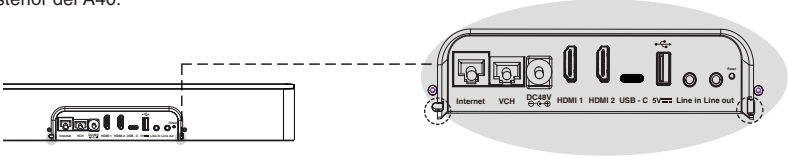

2 Inserte la parte A del cubre cables en las ranuras.

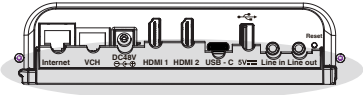

3 Ensambla la parte B y fija los tornillos.

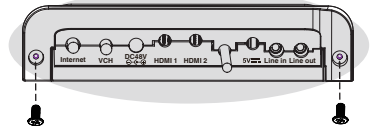

7 Instalación



Opción 1: Montar en el MeetingDisplay de Yealink

[Video de Instalación](#)

1

- Necesitas comprar el MeetingDisplay y el MD-AVBracket-S por separado. Para la instalación, por favor consulta la [Guía de Inicio Rápido del MD-AVBracket-S](#) incluida en el paquete correspondiente.
- Otros 6 tornillos (1/4 de pulgada x 12 mm) están incluidos en el paquete del MD-AVBracket-S.

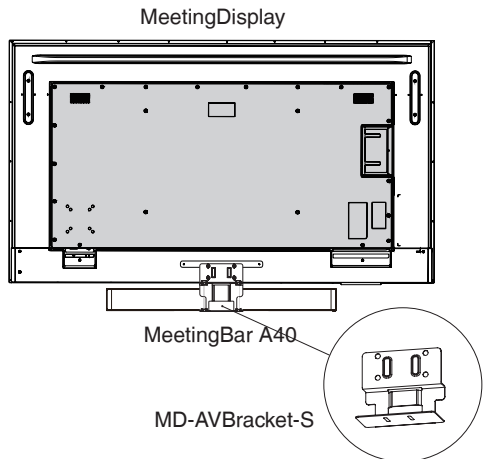
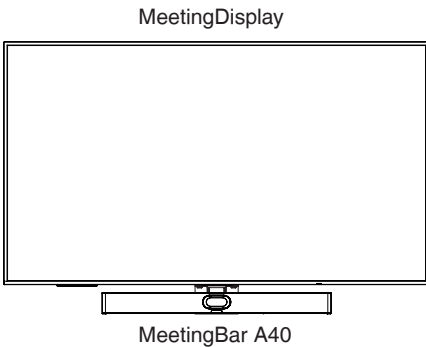

Opción 2: Montar en una Pared

Paso 1: Determinar la posición de A40

La altura de montaje afecta la vista de tu cámara. La altura recomendada de instalación es de 110 cm sobre el suelo, y la distancia reservada entre el A40 y la televisión debe ser mayor a 1 cm.

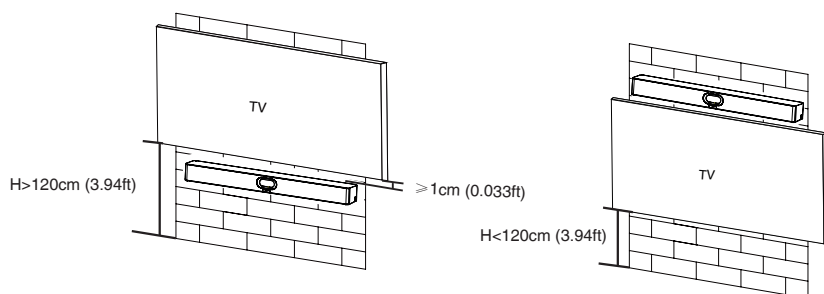

Paso 2: Monta el A40 en la pared

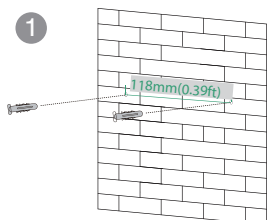
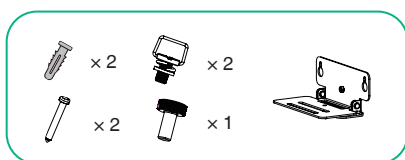

Profundidad del agujero: 30 mm (0.098ft)
Diámetro del agujero: 6 mm (0.02ft)

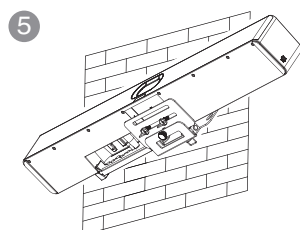
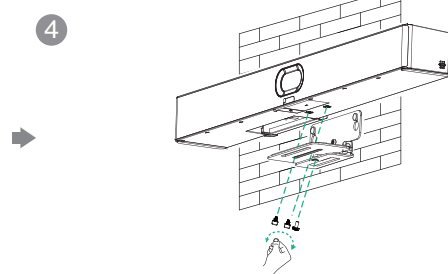
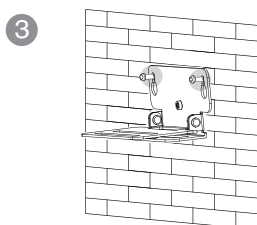
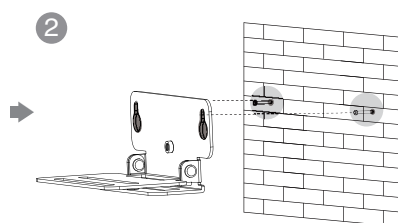

Opción 3: Montar Encima de un Televisor o una Pantalla

- El soporte M-2 se puede insertar en el M-1 en dos direcciones. Aquí nos enfocaremos en una dirección para la ilustración.
- Debido al peso del dispositivo, es recomendable evitar montarlo en televisores delgados para evitar posibles caídas o daños en la pantalla.

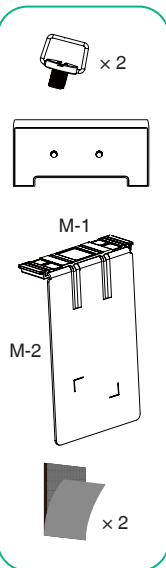
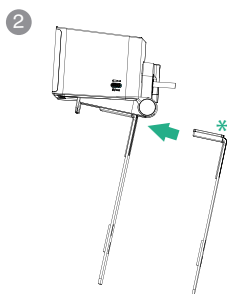
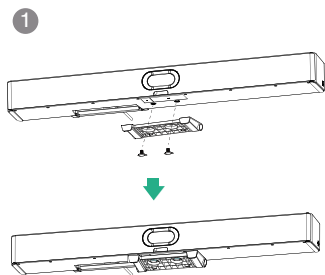

Presta atención a la dirección de la M-2

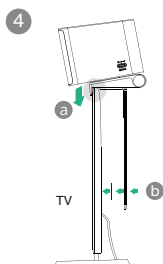
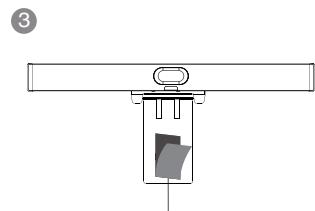

El Velcro A se coloca en el interior de M-2 de forma predeterminada.

Opción 4: Colócalo en una Superficie Plana

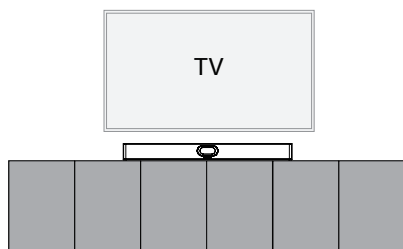

En el escritorio

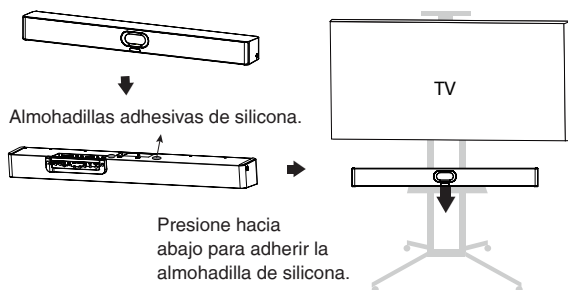

En la plataforma del carrito del soporte de televisión (compra por separado)

Opción 5: Incrustar en la Pared

1

- La altura de montaje afecta la vista de tu cámara. La altura de instalación recomendada es de 110 cm sobre el suelo.
- Mantenga la parte delantera del A40 al ras con la superficie de la pared.
- El margen recomendado en los lados izquierdo, derecho y superior del A40 es inferior a 0.5 cm.
- Deje una distancia de 5 ± 0.5 cm entre la parte trasera del A40 y la superficie de la pared para las conexiones de cables.

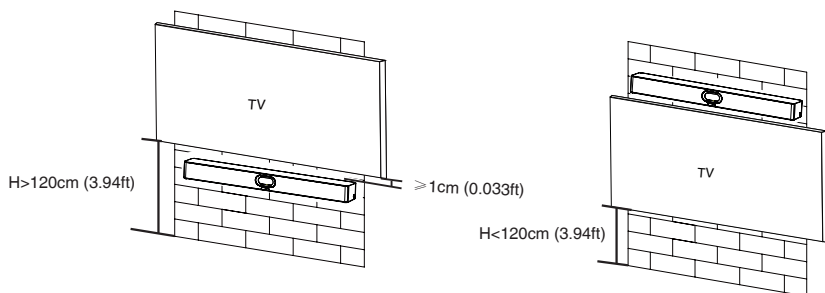

Opción 6: Montar en el Soporte de Mesa

1

Consulta la sección **8 Ajuste de la Inclinación de la Cámara** para el ajuste del soporte.

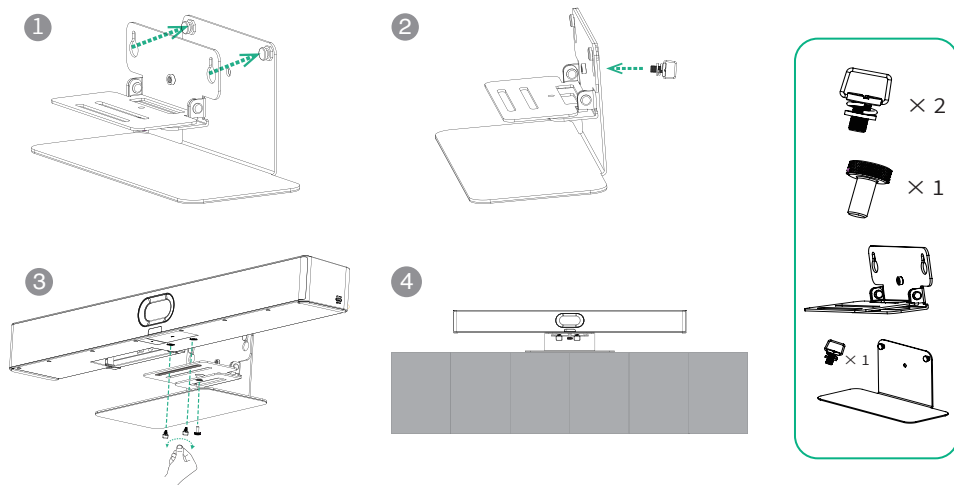

8 Ajusta la Inclinación de la Cámara

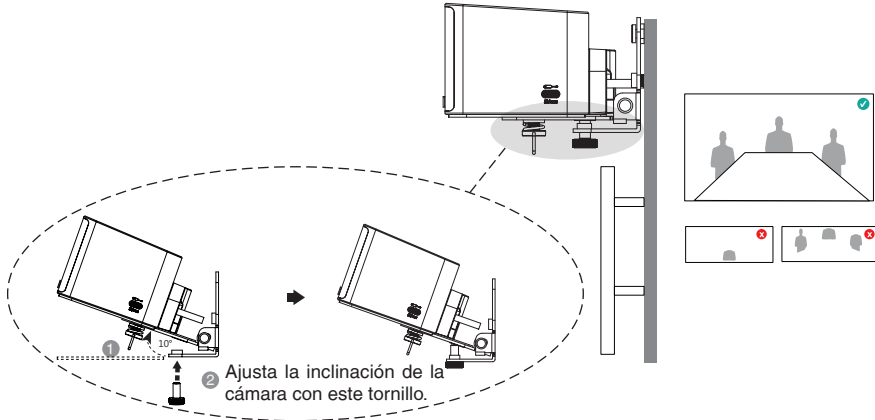

9 VCR11 (Opcional)

Puedes usar el control remoto (no aplicable a la versión de Zoom) o el CTP25 para operar el A40. Si se conecta un dispositivo con pantalla táctil, también puedes operar el A40 directamente en la pantalla táctil.

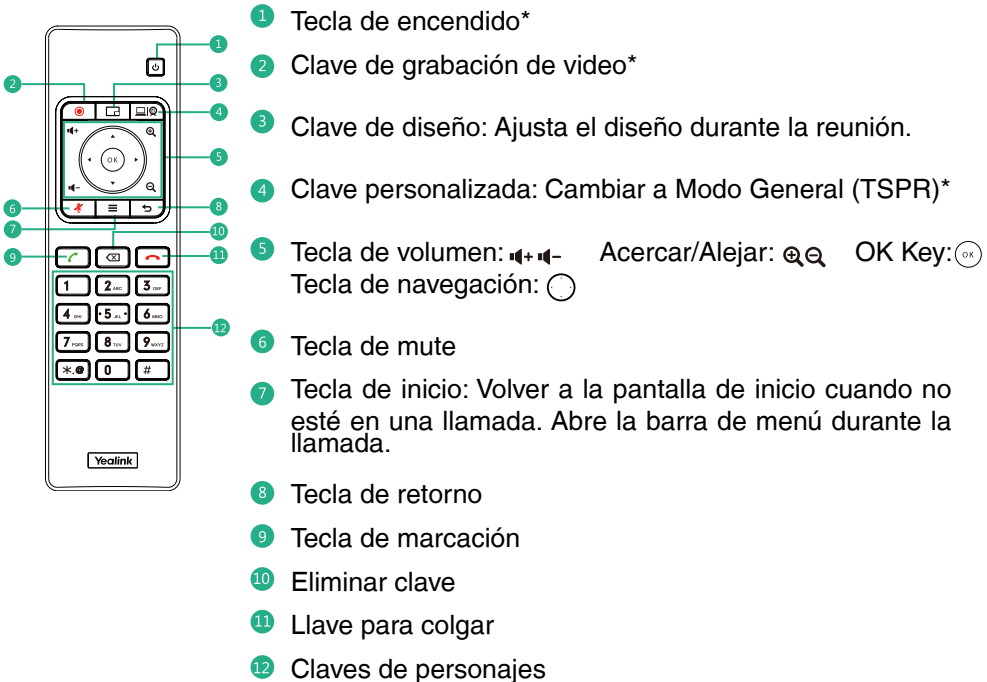

* Próximamente

Las claves admitidas en diferentes modos pueden ser diversas.

10 Pares Con el CTP25 (Opcional)

Para una mejor experiencia de emparejamiento, recomendamos empezar con el A40 y luego con el CTP25.

Emparejar manualmente

Si compró un kit de paquete o conectó CTP25 a A40 mediante un cable de red, A40 y CTP25 se emparejarán automáticamente. Puede ir directamente a [Inicialización](#).

En el CTP25, ingresa la dirección IP y el código de emparejamiento del A40 que aparece en la pantalla.

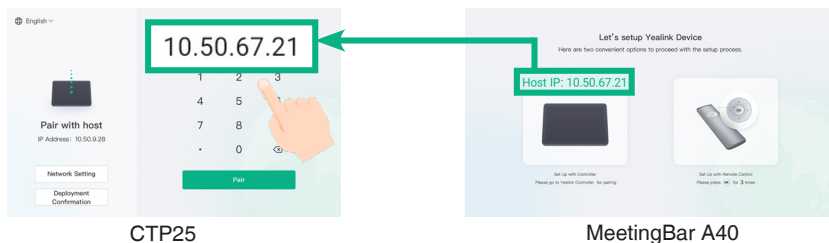

Inicialización

1. Si el CTP25 se restaura a los ajustes de fábrica, es necesario cambiar la contraseña predeterminada (0000) del CTP25.
2. Inicializar el **idioma**, la **red**, la **zona horaria** y la **actualización automática**, y seleccionar la plataforma deseada. Si seleccionas el **Modo General (TSPR)**, consulta la sección [11 Modo General \(Traiga su propia reunión\)](#).
3. Cambia la contraseña predeterminada (0000) del A40.

Inicio de Sesión de Cuenta

Contacta al proveedor de servicios correspondiente para obtener una cuenta.

Sigue las indicaciones en A40 y CTP25 para iniciar sesión en la misma cuenta.

11 Modo General (Traiga su propia reunión)

1. Haga una de las siguientes opciones para seleccionar el **Modo General (TSPR)**:
 - Al seleccionar una plataforma durante la inicialización de encendido, selecciona el **Modo General (TSPR)**.
 - Después de iniciar sesión, restablecer a configuración de fábrica para cambiar de plataforma.
2. Consulte la sección [12 Compartir contenido y BYOD](#) para compartir contenido o utilizar la función BYOD.

12 Compartir Contenido y BYOD (opcional)

Compartir contenido

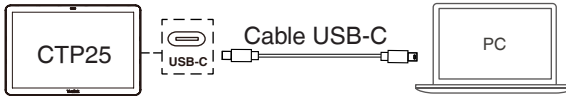

BYOD

Ve a la interfaz web y entra en **Sistema > Proveedor de UC** para habilitar BYOD.

Utilice el cable USB-C para conectar el CTP25 a la PC y siga las indicaciones para ingresar al modo BYOD.

13 Actualizar el Firmware

Actualización Automática

Haga una de las siguientes acciones:

- Durante la inicialización al encender, activa la **Actualización Automática**.
- En la configuración, activa la **Actualización automática**.

Actualización Manual

Actualizar el firmware de MeetingBar A40 y CTP25 por separado.

1. Obtener la dirección IP.
2. Abre un navegador web e introduce la dirección IP del dispositivo en la barra de direcciones. Por ejemplo, <https://10.82.24.11/> y presiona **Enter**.
3. Ingrese el nombre de usuario del administrador y la contraseña, y haga clic en **Iniciar sesión**. El nombre de usuario predeterminado es "admin" y la contraseña es "0000".
4. Ve a **Sistema > Actualización**.
5. En el lado derecho del **Firmware del Dispositivo**, haz clic en Seleccionar Archivo para subir el firmware deseado.
6. Haz clic en **Actualizar**.

Por favor, obtén el firmware más reciente en <https://support.yealink.com/>.



Declaration of Conformity

We,

YEALINK(XIAMEN) NETWORK TECHNOLOGY CO.,LTD

Address: No.666 Hu'an Rd. Huli District Xiamen City, Fujian, P.R. China

Manufacturer: YEALINK(XIAMEN) NETWORK TECHNOLOGY CO.,LTD

Address: No.666 Hu'an Rd. Huli District Xiamen City, Fujian, P.R. China

DATE: 26 / May /2024

declare that the product

Type: Video Conferencing Endpoint

Model: MeetingBar A40

meets the essential requirements and other relevant provisions according to the following EC

directive **Directive: 2014/30/EU, 2014/35/EU,RED 2014/53/EU**

Conformity

The product complies with the following standards:

Safety : **EN 62368-1:2020+A11:2020**

EMC: **EN 55032:2015+A11:2020**

EN 55035:2017+A11:2020

EN IEC 61000-3-2: 2019+A1:2021

EN 61000-3-3: 2013+A2:2021

Radio:ETSI EN 301 489-1 V2.2.3,

ETSI EN 301 489-3 V2.3.2 (2023-01) ,

ETSI EN 301 489-17 V3.2.4,

ETSI EN 300 328 V2.2.2;

ETSI EN 301 893 V2.1.1

ETSI EN 300 440 V2.2.1

Health :EN IEC 62311:2020&EN 50665:2017;

Harmonized: UN-EN62321

Directive 2011/65/EU and (EU)2015/863 of the European Parliament and of the Council of 8 June 2011 and 4 June 2015 on the restriction of the use of certain hazardous substances in electrical and electronic equipment(RoHS 2.0)

Directive 2012/19/EU of the European Parliament and of the Council of 4.July.2012 on Waste electrical and electronic equipment(WEEE)

Regulation (EC) No.1907/2006 of the European Parliament and of the Council of 18.December.2006 on Registration, Evaluation, Authorization, and Restriction of Chemicals (REACH)

The declaration of conformity is issued under the sole responsibility of the manufacturer

NAME: Huahu Wang

DATE:

TITLE: Manager

Addr: No.666 Hu'an Rd. Huli District Xiamen City, Fujian, P.R.
China

Tel: +86-592-5702000
Fax: +86-592-5702455

About Yealink

Yealink (Stock Code: 300628) is a global-leading provider of Unified Communication & Collaboration Solutions specialized in video conferencing, voice communications, and collaboration, dedicated to helping every person and organization embrace the power of "Easy Collaboration, High Productivity".

With best-in-class quality, innovative technology, and user-friendly experiences, Yealink is one of the best providers in more than 140 countries and regions, ranks No.1 in the global market share of IP Phone, and is the Top 5 leader in the video conferencing market (Frost & Sullivan, 2021).

Technical Support

Visit Yealink WIKI (<http://support.yealink.com/>) for firmware downloads, product documents, FAQ, and more. For better service, we sincerely recommend you to use Yealink Ticketing system (<https://ticket.yealink.com>) to submit all your technical issues.



430104003459

YEALINK(XIAMEN) NETWORK TECHNOLOGY CO.,LTD.

Web: www.yealink.com

Addr: No.666 Hu'an Rd,Huli District Xiamen City, Fujian, P.R.
China

Copyright©2025 Yealink Inc. All right reserved.